

YAMAHA

DIGITAL REVERBERATOR

REVS

Operating Manual

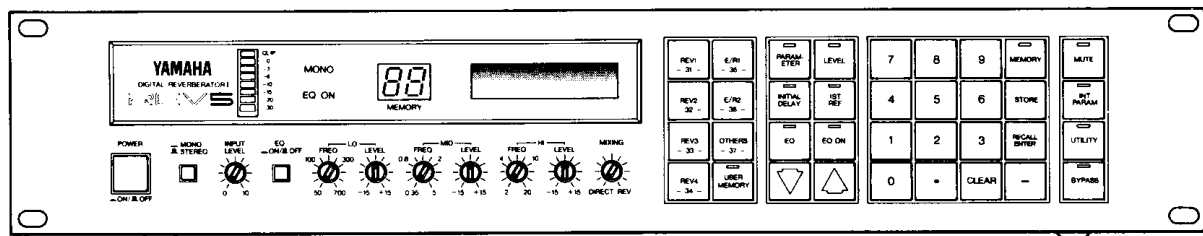

Congratulations on your acquisition of a Yamaha REV5 Digital Reverberator.

The REV 5 is a highly sophisticated digital reverberation and effects system which offers warm, accurate simulations of natural and plate reverberation, extensive control, and basically superior sound quality. With a sampling frequency of 44.1 kHz, it delivers full, flat frequency response from 20 Hz to 20 kHz for exceptionally clean, "transparent" effect sound and a broader control range.

A total of 39 preset effect programs are provided that can be edited, re-titled, and stored in any of 60 RAM user memory locations. Programs 1 through 30 cover a range of reverb, early reflection, delay, modulation, gated reverb and pitch change effects, while programs 91 through 99 provide a unique set of "combination" programs which effectively function as several REV5 units in one. Individual three-band parametric EQ parameters are provided for each effect program for precise tonal tailoring.

In addition to the basic effect and EQ parameters, the REV5 offers a list of "internal parameters" which provide exacting control over the effect sound. The REVERB programs, for example, feature a total of 12 parameters that make it possible to create precisely the required effect.

The REV5 is also MIDI compatible, with a MIDI IN terminal that allows MIDI selection of effect programs, and a switchable MIDI THRU/OUT terminal. When switched to OUT, edited programs stored in internal RAM can be dumped to a MIDI data recorder or other data storage device. Programs thus stored can be reloaded when necessary via the MIDI IN terminal.

As an extra touch of convenience the REV5's electronically balanced input and output terminals can be switched to match -20 dBm or +4 dBm line levels—providing compatibility with a broader range of sound equipment.

In order to fully take advantage of all the capability offered by the REV5 Digital Reverberator, we urge you to read this operating manual thoroughly.

IMPORTANT NOTICE FOR THE UNITED KINGDOM

Connecting the Plug and Cord

WARNING : THIS APPARATUS MUST BE EARTHED

IMPORTANT. The wires in this mains lead are coloured in accordance with the following code:

GREEN-AND-YELLOW	: EARTH
BLUE	: NEUTRAL
BROWN	: LIVE

As the colours of the wires in the mains lead of this apparatus may not correspond with the coloured markings identifying the terminals in your plug proceed as follows:

The wire which is coloured GREEN-AND-YELLOW must be connected to the terminal in the plug which is marked by the letter E or by the safety earth symbol  or coloured GREEN or GREEN-AND-YELLOW.

The wire which is coloured BLUE must be connected to the terminal which is marked with the letter N or coloured BLACK.

The wire which is coloured BROWN must be connected to the terminal which is marked with the letter L or coloured RED.

* This applies only to products distributed by YAMAHA - KEMBLE MUSIC (U.K.) LTD.

Table of Contents

<p>PRECAUTIONS 3</p> <p>1: CONTROLS AND CONNECTIONS 4</p> <p style="padding-left: 20px;">THE FRONT PANEL 4</p> <p style="padding-left: 20px;">THE CONNECTOR PANEL 6</p> <p style="padding-left: 20px;">RC-5 REMOTE CONTROL UNIT 7</p> <p>2: GENERAL OPERATION 8</p> <p style="padding-left: 20px;">MEMORY CONFIGURATION 8</p> <p style="padding-left: 20px;">SELECTING AN EFFECT/MEMORY LOCATION 8</p> <p style="padding-left: 40px;">Direct Recall (Remote Control Recall) 8</p> <p style="padding-left: 40px;">Increment/Decrement Recall 9</p> <p style="padding-left: 40px;">Numeric Selection 9</p> <p style="padding-left: 20px;">BYPASSING THE EFFECT 10</p> <p style="padding-left: 20px;">ACCESSING & EDITING</p> <p style="padding-left: 40px;">THE PROGRAM PARAMETERS 10</p> <p style="padding-left: 20px;">STORING EFFECTS 12</p> <p>3: DESCRIPTIONS OF PROGRAM TYPES & PARAMETERS ... 14</p> <p style="padding-left: 20px;">PARAMETERS PROVIDED</p> <p style="padding-left: 40px;">FOR ALL PROGRAMS ... 14</p> <p style="padding-left: 20px;">LEVEL PARAMETERS 14</p> <p style="padding-left: 20px;">INITIAL DELAY PARAMETER 14</p> <p style="padding-left: 20px;">1ST REFLECTION PARAMETERS 14</p> <p style="padding-left: 20px;">EQ PARAMETERS 15</p> <p style="padding-left: 20px;">REVERB TYPE PROGRAMS 16</p> <p style="padding-left: 20px;">EARLY REFLECTION 1 AND</p> <p style="padding-left: 40px;">2 TYPE PROGRAMS ... 19</p> <p style="padding-left: 40px;">Early Reflection Mode Chart 22</p> <p style="padding-left: 40px;">Room Size Chart 24</p> <p style="padding-left: 20px;">DELAY & ECHO TYPE PROGRAMS 25</p> <p style="padding-left: 20px;">MODULATION TYPE PROGRAMS 27</p> <p style="padding-left: 20px;">PITCH CHANGE TYPE PROGRAMS 32</p> <p style="padding-left: 20px;">COMBINATION GATED PROGRAMS 36</p>	<p>4: UTILITY FUNCTIONS 42</p> <p style="padding-left: 20px;">TITLE EDIT 42</p> <p style="padding-left: 20px;">MIDI BANK & CHANNEL ASSIGNMENT 43</p> <p style="padding-left: 20px;">BULK OUT 45</p> <p style="padding-left: 20px;">FOOTSWITCH MEMORY RECALL RANGE .. 46</p> <p>5: MIDI DATA FORMAT 47</p> <p>6: APPLICATION EXAMPLES 53</p> <p>7: SPECIFICATIONS 54</p> <p>8: BLOCK DIAGRAM 55</p> <p>9: DIMENSIONS 55</p> <p>10: ROM CONTENTS AND CONTROLLABLE PARAMETERS 56</p> <p>11: BLANK CHART 95</p>
---	---

CANADA

THIS DIGITAL APPARATUS DOES NOT EXCEED THE "CLASS B" LIMITS FOR RADIO NOISE EMISSIONS FROM DIGITAL APPARATUS SET OUT IN THE RADIO INTERFERENCE REGULATION OF THE CANADIAN DEPARTMENT OF COMMUNICATIONS.

LE PRESENT APPAREIL NUMERIQUE N'EMET PAS DE BRUITS RADIOELECTRIQUES DEPASSANT LES LIMITES APPLICABLES AUX APPAREILS NUMERIQUES DE LA "CLASSE B" PRESCRITES DANS LE REGLEMENT SUR LE BROUILLAGE RADIOELECTRIQUE EDICTE PAR LE MINISTERE DES COMMUNICATIONS DU CANADA.

* This applies only to products distributed by YAMAHA CANADA MUSIC LTD.

PRECAUTIONS

1. AVOID EXCESSIVE HEAT, HUMIDITY, DUST AND VIBRATION

Keep the unit away from locations where it is likely to be exposed to high temperatures or humidity—such as near radiators, stoves, etc. Also avoid locations which are subject to excessive dust accumulation or vibration which could cause mechanical damage.

2. AVOID PHYSICAL SHOCKS

Strong physical shocks to the unit can cause damage. Handle it with care.

3. DO NOT OPEN THE UNIT OR ATTEMPT REPAIRS OR MODIFICATIONS YOURSELF

This product contains no user-serviceable parts. Refer all maintenance to qualified Yamaha service personnel. Opening the unit and/or tampering with the internal circuitry will void the warranty.

4. MAKE SURE POWER IS OFF BEFORE MAKING OR REMOVING CONNECTIONS

Always turn the power OFF prior to connecting or disconnecting cables. This is important to prevent damage to the unit itself as well as other connected equipment.

5. HANDLE CABLES CAREFULLY

Always plug and unplug cables—including the AC cord—by gripping the connector, not the cord.

6. ELECTRICAL INTERFERENCE

Since the REV5 contains digital circuitry, it may cause interference and noise if placed too close to TV sets, radios or similar equipment. If such a problem does occur, move the REV5 further away from the affected equipment.

7. CLEAN WITH A SOFT DRY CLOTH

Never use solvents such as benzine or thinner to clean the unit. Wipe clean with a soft, dry cloth.

8. ALWAYS USE THE CORRECT POWER SOURCE

Make sure that the power source voltage specified on the rear panel matches your local AC mains source.

U.S. & Canadian Model: 110—120V AC, 50/60 Hz
General Model: 220—240V AC, 50/60 Hz

9. XLR TYPE CONNECTORS

The XLR type Input and Output connectors are wired in the following configuration: Pin 1: GROUND, Pin 2: Hot, Pin 3: COLD. Ensure that all equipment connected to the REV5 matches this wiring.

10. BACKUP BATTERY

The REV5 contains a long-life lithium battery which maintains the contents of the buffer and user memory locations even when the unit is turned OFF. With normal use the battery should last for approximately 5 years. If the battery voltage falls below the safe level, however, the “** WARNING ** LOW BATTERY” display will appear on the LCD when the power is first turned ON. If this occurs, have the battery replaced by a qualified Yamaha service center. Do not attempt to replace the battery yourself!

** WARNING **
LOW BATTERY

FCC INFORMATION (U.S.A.)

1. IMPORTANT NOTICE: DO NOT MODIFY THIS UNIT!

This product, when installed as indicated in the instructions contained in this manual, meets FCC requirements. Modifications not expressly approved by Yamaha may void your authority, granted by the FCC, to use the product.

2. IMPORTANT: When connecting this product to accessories and/or another product use only high quality shielded cables. Cable/s supplied with this product MUST be used. Follow all installation instructions. Failure to follow instructions could void your FCC authorization to use this product in the USA.

3. NOTE: This product has been tested and found to comply with the requirements listed in FCC Regulations, Part 15 for Class “B” digital devices. Compliance with these requirements provides a reasonable level of assurance that your use of this product in a residential environment will not result in harmful interference with other electronic devices. This equipment generates/uses radio frequencies and, if not installed and used according to the instructions found in the users manual, may cause interference harmful to the operation of other electronic devices. Compliance with FCC regulations does not guarantee that interference will not occur in all installations. If this product is found to be the source of interference, which can be determined by turning the unit “OFF” and “ON”, please try to eliminate the problem by using one of the following measures:

Relocate either this product or the device that is being affected by the interference.

Utilize power outlets that are on different branch (circuit breaker or fuse) circuits or install AC line filter/s.

In the case of radio or TV interference, relocate/reorient the antenna. If the antenna lead-in is 300 ohm ribbon lead, change the lead-in to co-axial type cable.

If these corrective measures do not produce satisfactory results, please contact the local retailer authorized to distribute this type of product. If you can not locate the appropriate, please contact Yamaha Corporation of America, Electronic Service Division, 6600 Orangethorpe Ave, Buena Park, CA 90620

* This applies only to products distributed by YAMAHA CORPORATION OF AMERICA.

1: CONTROLS AND CONNECTIONS

THE FRONT PANEL

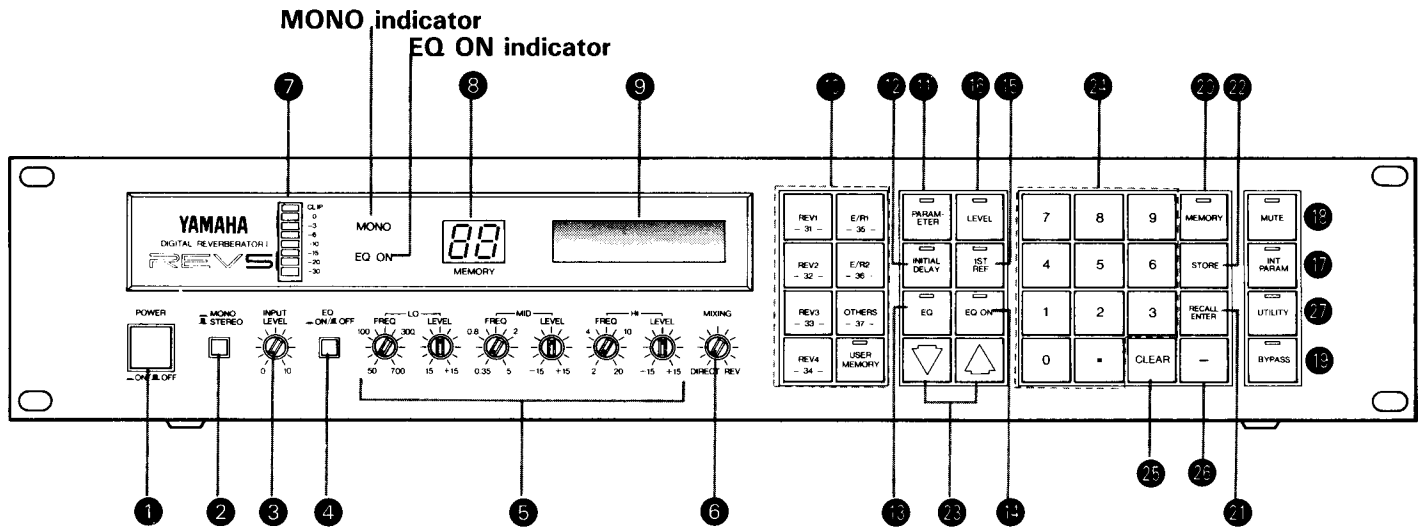

1 Power ON/OFF Switch

When the power is turned ON, the last program and parameter selected will be automatically recalled.

2 Mono/Stereo Switch

This switch must be set according to whether a stereo or mono signal is fed to the REV5 inputs. If a stereo signal is applied to both the R and L inputs, the MONO switch should be turned OFF (OUT position).

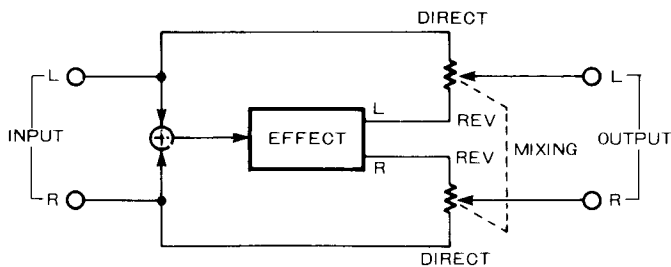

If a monaural input signal is used, it must be applied to the L (Mono) input and the MONO switch must be turned ON. When ON, the "MONO" indicator will light.

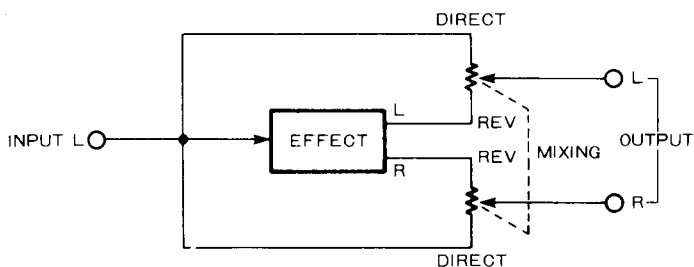

3 Input Level Control

Varies the input level from approximately -90 dB to $+10$ dB when the rear-panel input level switch is set to $+4$ dB, and between approximately -110 dB and -14 dB when the input level switch is set to -20 dB.

4 EQ ON/OFF Switch

Turns the main analog parametric equalizer (front-panel controls) ON or OFF. When switched ON, the EQ ON indicator will light.

5 Equalizer Section

A three-band parametric equalizer which equalizes the input signal prior to digital processing. The direct signal is NOT equalized. Each of the three bands has a level control and a frequency control. The frequency ranges are:

LO: 50 Hz – 700 Hz

MID: 0.35 kHz – 5 kHz

HI: 2 kHz – 20 kHz

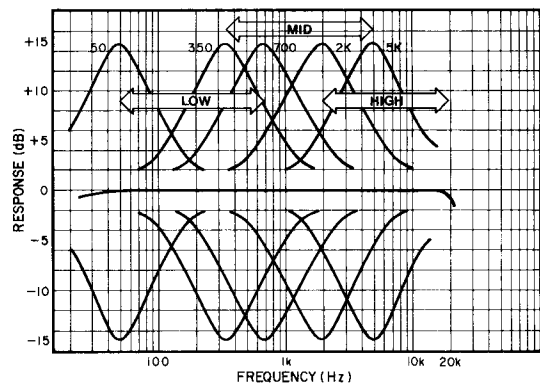

6 Mixing Control

Permits balancing the direct and processed signals. When turned fully to the right only the processed sound is output, and when turned fully to the left only the direct sound is output.

7 Input Level Meter

The input level meter consists of eight LED segments corresponding to -30 dB, -20 dB, -15 dB, -10 dB, -6 dB, -3 dB, 0 dB and CLIP input level.

8 LED Memory Number Display

This 2-digit numeric display shows the number of the currently selected memory location (1-99). When the LED display is continuously lit the effect corresponding to the number displayed is active. When the LED display is flashing, this indicates that a new memory location has been selected but has not yet been recalled, leaving the previously selected effect active.

9 LCD (Liquid Crystal Display)

This 16-character x 2-line liquid crystal display panel normally displays the title of the selected effect on the top line and a selected parameter and its value on the bottom line. One or both lines may also be used to display error messages or warnings.

10 Direct Program Recall Keys

These keys allow direct one-touch recall of preset programs 1 through 30, and the first 7 user memory locations.

11 Effect Parameter Select Key

Accesses the main effect parameters for each program.

12 Initial Delay Parameter Select Key

Accesses the initial delay time parameter for each program.

13 EQ Parameter Select Key

Accesses the three-band digital parametric equalizer parameters for each program.

14 EQ ON/OFF Key

Turns the internal EQ for the currently selected program ON or OFF.

15 1st Reflection Parameter Select Key

Accesses the center channel, left channel and right channel 1st reflection parameters for each program.

16 Level Parameter Select Key

Accesses the output level, balance and output phase parameters for each program.

17 Internal Parameter Select Key

Accesses a special set of internal parameters for each effect program.

18 Mute Key

Pressing this key completely shuts off output from the REV5.

19 Bypass Key

The BYPASS key switches the selected effect ON or OFF, leaving the direct signal only when BYPASS is active.

20 Memory Key

Pressing this key engages the memory selection mode, allowing a new memory location to be selected using the Δ and ∇ keys. In this operating manual, the up-arrow key will be denoted by a Δ and the down-arrow key by a ∇ .

21 Recall/Enter Key

When a new memory location number has been selected using the Δ and ∇ keys, the RECALL key must be pressed to activate the selected effect.

22 Store Key

This key is used to store edited effect parameters into one of the user memory locations between 31 and 90.

23 Increment/Decrement Keys

These keys are used to select memory locations when the memory selection mode is active (after the MEMORY key has been pressed), or to change parameter values when parameters are selected for editing (after any of the parameter select keys has been pressed). The Δ and ∇ keys are also used to program several UTILITY functions.

24 Numeric/Editing Keys

This 10-key entry pad allows direct entry of program numbers for recall or storage, and direct numeric input of parameter values.

● **CLEAR Key**

If an error is made entering a numeric value via the Numeric/Editing keys, the CLEAR key can be used to cancel the incorrect value.

● **– (Minus) Key**

The minus key is used to enter negative parameter values via the Numeric/Editing keys.

● **Utility Key**

This key accesses a list of utility functions allowing editing of effect titles, MIDI channel programming, assigning effects to MIDI program change numbers, bulk out operation and footswitch memory recall range programming.

THE CONNECTOR PANEL

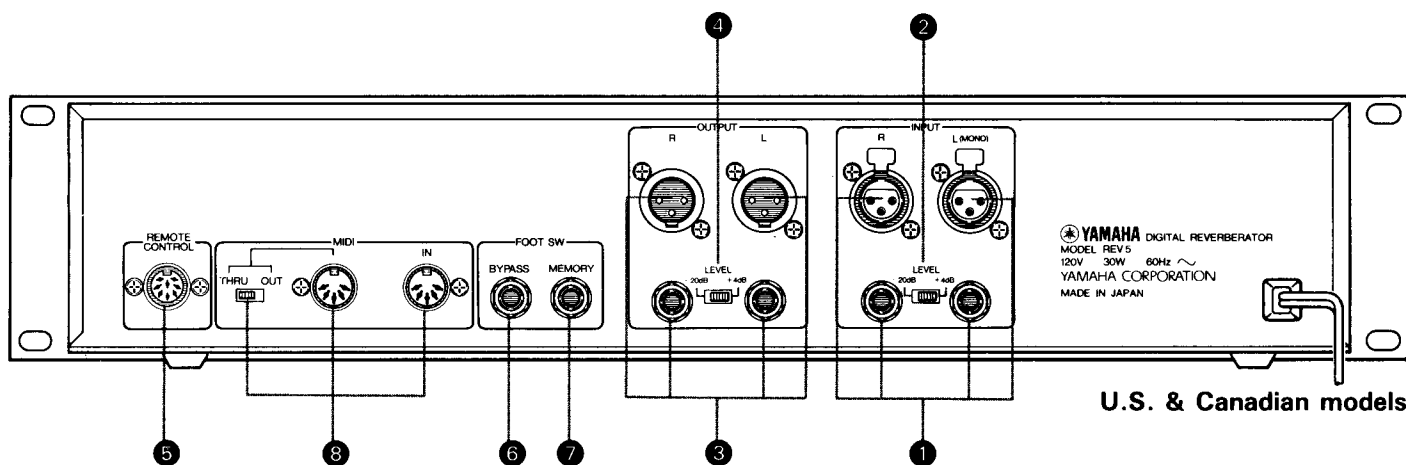

● **1 L (MONO) & R Input Connectors**

The REV5 can accept stereo or mono signals for processing. Both 1/4" balanced TRS phone input jacks and XLR type balanced input connectors are provided. The TRS phone jacks will also accept standard 1/4" monaural phone plugs. The LEVEL switch selects either -20 dB or +4 dB nominal input level.

When feeding the REV5 a mono signal, connect it to the L (MONO) connector and set the front-panel MONO/STEREO switch to MONO. The direct signal will then appear equally at the L and R stereo outputs (i.e. center of stereo sound field).

● **2 Input Connectors Level Switch**

This LEVEL switch selects either -20 dB or +4 dB nominal input level.

● **3 R & L Output Connectors**

The REV5 provides both 1/4" balanced TRS phone output jacks and XLR type balanced output connectors.

● **4 Output Connectors Level Switch**

This LEVEL switch selects either -20 dB or +4 dB nominal output level.

● **5 Remote Control Connector**

The RC-5 remote control unit supplied with the REV5 is plugged in here.

6 Bypass Footswitch Jack

An optional Yamaha FC5 footswitch or equivalent connected to this jack can be used for foot control of the BYPASS function.

7 Memory Footswitch Jack

An optional Yamaha FC5 footswitch or equivalent connected to this jack can be used to recall a range of programs specified by the UTILITY mode F.SW MEMORY RECALL RANGE function.

8 MIDI IN and THRU/OUT Terminals

MIDI signals from external MIDI devices can be fed to the MIDI IN terminal to remotely select effects and set the pitch shift of the PITCH CHANGE effects. When the switch controlling the remaining MIDI terminal is set to THRU, the terminal simply re-transmits data received at the MIDI IN terminal allowing daisy-chaining of MIDI devices. When set to OUT, the internal RAM memory contents may be dumped to a MIDI data recorder for large-volume, long-term storage. Program data thus stored can be re-loaded later via the MIDI IN terminal.

RC-5 REMOTE CONTROL UNIT

The RC-5 Remote Control Unit provides a set of keys which duplicate the functions of the Direct Program Recall Keys on the front panel. These keys permit remote one-touch recall of preset programs 1 through 30, and the first 7 user memory locations.

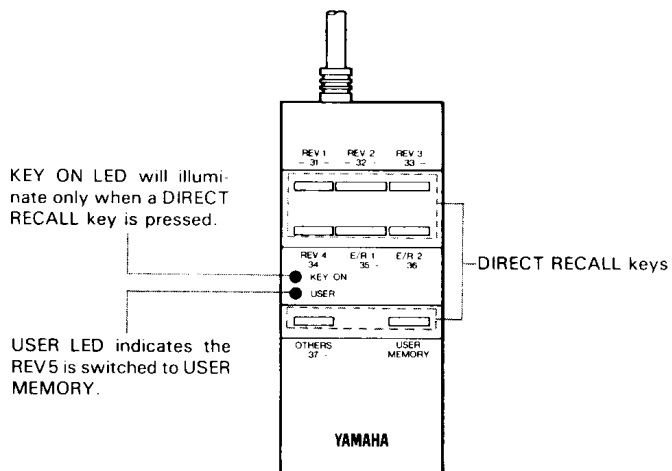

2: GENERAL OPERATION

MEMORY CONFIGURATION

The REV5 has a total of 99 internal memory locations. Locations 1 through 30, and locations 91 through 99 are READ-ONLY MEMORY containing the 39 preset effect programs. These locations cannot be written to or changed in any way. The effect programs contained in memory locations 1 through 30 are:

Mem. No.	Program Name	Mem. No.	Program Name
1	LARGE HALL	16	SPRING
2	SMALL HALL	17	ECHO ROOM
3	VOCAL PLATE	18	STRINGS
4	PERCUSSION PLATE	19	ELECTRIC BASS A
5	EARLY REF. 1	20	ELECTRIC BASS B
6	EARLY REF. 2	21	KICK
7	DELAY L, R	22	SNARE
8	STEREO ECHO	23	REVERB & GATE
9	STEREO FLANGE	24	REVERSE GATE
10	REVERB FLANGE	25	REHEARSAL ROOM
11	CHORUS A	26	PITCH CHANGE A
12	CHORUS B	27	PITCH CHANGE B
13	STEREO PHASING	28	PITCH CHANGE C
14	TREMOLO	29	PAN
15	SYMPHONIC	30	LIVE REFERENCE

The combined effect programs contained in locations 91 through 99 are:

Mem. No.	Program Name
91	ECHO & REV & G (Echo/reverb/gate)
92	CHORUS & REV & G (Chorus/reverb/gate)
93	SYMPHO. & REV & G (Symphonic/reverb/gate)
94	PC & REV & G (Pitch change A/reverb/gate)
95	REV & SYMPHO. & G (Reverb/symphonic/gate)
96	REV & PAN & G (Reverb/pan/gate)
97	REV & PC & G (Reverb/pitch change C/gate)
98	ER + REV & G (Parallel ER and REV/gate)
99	PLATE + HALL & G (Parallel REV and REV/gate)

Locations 31 through 90 are READ/WRITE MEMORY which can be used to store your own edited versions of the preset programs.

When shipped, the user RAM memory locations contain copies of the preset programs in ROM locations 1 through 30.









SELECTING AN EFFECT/ MEMORY LOCATION

The REV5 offers three different ways to select a specific memory location: direct recall, increment/decrement recall, and numeric selection.

Direct Recall (Remote Control Recall)

Direct Recall permits one-touch recall of preset memory locations 1 through 30, and the first 7 user memory locations.

When the USER MEMORY key is OFF (its LED is out), pressing the following keys instantly calls the following programs:

	 not lit Preset Programs	 lit User Programs
	1. LARGE HALL	Program number 31.
	2. SMALL HALL	Program number 32.
	3. VOCAL PLATE	Program number 33.
	4. PERCUSSION PLATE	Program number 34.
	5. EARLY REF. 1	Program number 35.
	6. EARLY REF. 2	Program number 36.
	7. DELAY L, R ↓ 30. LIVE REFERENCE (Repeated pressings)	Program number 37.

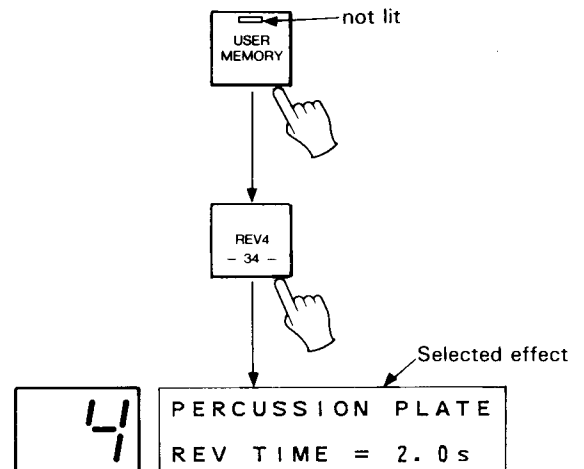

The OTHERS key initially calls program 7 (DELAY L, R), with subsequent presses on the same key calling programs 8 through 30, then back to 7. Use the OTHERS key in this way to select any program between 7 and 30, then whenever the OTHERS key is pressed from a different mode, the selected program number will be instantly recalled.

When the USER MEMORY key is ON (its LED is lit) the direct memory recall keys call user memory programs 31 through 37 as marked at the bottom of each key.

Increment/Decrement Recall

- ① Press the MEMORY key to activate the memory selection mode. This is not necessary if the memory selection mode is already active, but it's a good habit to get into to ensure smooth operation.
- ② Press the Δ or ∇ key to increment or decrement the memory location number shown on the LED display. Hold either of these keys down for continuous incrementing or decrementing. The name of the program corresponding to the currently selected memory location will be shown on the LCD.

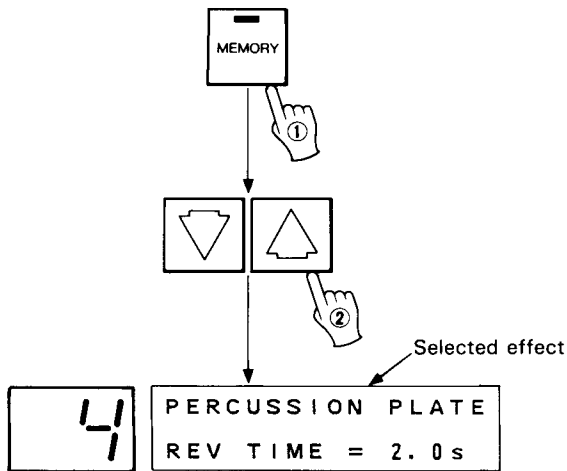

Numeric Selection

- ① Press the MEMORY key to activate the memory selection mode.
- ② Enter the number of the desired memory location using the Numeric/Editing keys. If you make a mistake and wish to re-enter the program number, press the CLEAR key and re-enter the program number. Note that at this stage the LED memory number display is flashing, indicating that although a new program number has been entered, the program itself has not yet been recalled.
- ③ Press the RECALL/ENTER key. The LED memory number display will stop flashing and the selected program will be engaged.

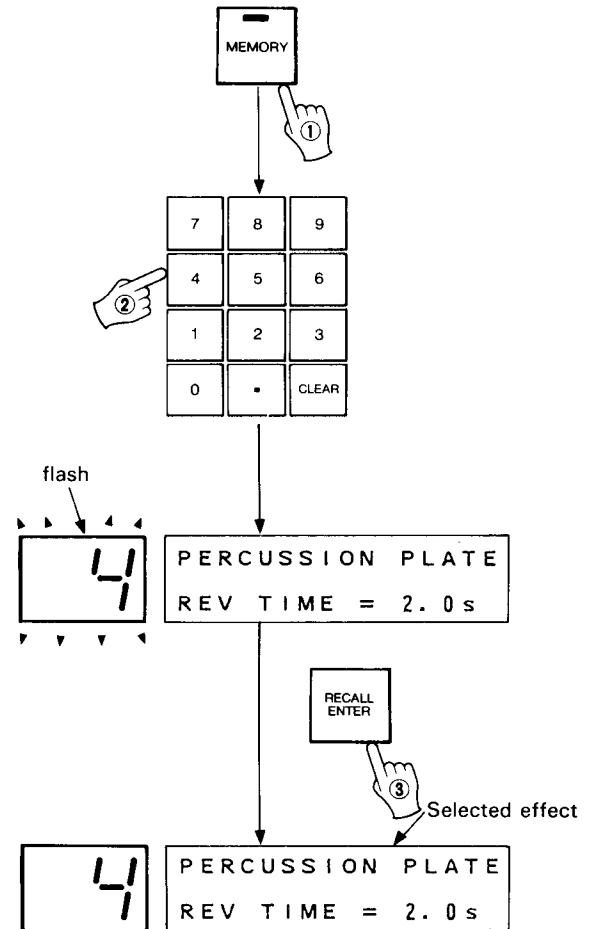

BYPASSING THE EFFECT

There are two ways to switch the selected effect in and out: 1) with the control panel BYPASS switch and 2) with a footswitch connected to the connector-panel BYPASS footswitch jack. An optional Yamaha FC5 Footswitch can be used for foot-bypass control. In either case—when the control-panel BYPASS key or BYPASS footswitch is pressed—the LED in the BYPASS key will light to indicate that the selected program is currently being bypassed and the input signal is directly routed to the output terminals (i.e. the effect is OFF). Press the BYPASS key or footswitch a second time to turn the effect back ON.

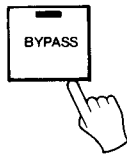

ACCESSING & EDITING THE PROGRAM PARAMETERS

Each REV5 program has 6 different groups of parameters which are accessed by pressing the corresponding parameter select keys:

KEY	ACCESSES
PARAMETER	The main effect parameters for each program. These parameters will vary according the type of program.
LEVEL	The BALANCE, OUT LVL and OUT PHASE parameters for each program.
INITIAL DELAY	The INI. DLY parameter for each program. The INITIAL DELAY key accesses only one parameter.
1ST REF	The Cch DLY, Cch LVL, Lch DLY, Lch LVL, Rch DLY and Rch LVL parameters for each effect.
EQ	Three-band parametric equalization parameters for each program.
INT PARAM	Special "fine control" parameters for each program. These parameters will vary according to the type of program.

To call a specific group of parameters for the currently selected effect program, press the appropriate parameter select key. For all parameter groups except INITIAL DELAY, which contains only a single parameter, the next parameter within the group is called each time the parameter select key for that group is pressed. For example, subsequent presses on the LEVEL parameter select key call the following parameters:

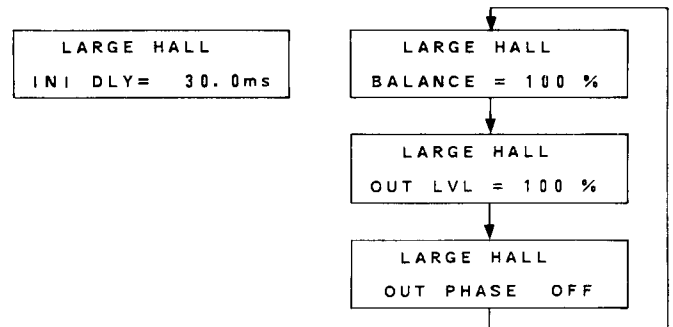

The complete procedure for calling and editing parameters is:

- ① Select and recall the program to be edited.
- ② Press the parameter select key corresponding to the group of parameters to be edited (PARAMETER, LEVEL, INITIAL DELAY, 1ST REF, EQ or INT PARAM) and the first of the selected group's parameters will appear on the bottom line of the LCD.
- ③ Once the desired parameter has been called, its value can be edited using the Δ and ∇ keys, or the Numeric/Editing keys. The Δ key increases (increments) the value while the ∇ key decreases (decrements) the value. Either key can be held down for continuous incrementing or decrementing. Using the Numeric/Editing keys it is possible to directly enter the desired value, which will then flash on the LCD.
- ④ Press the RECALL/ENTER key to actually engage the entered value.

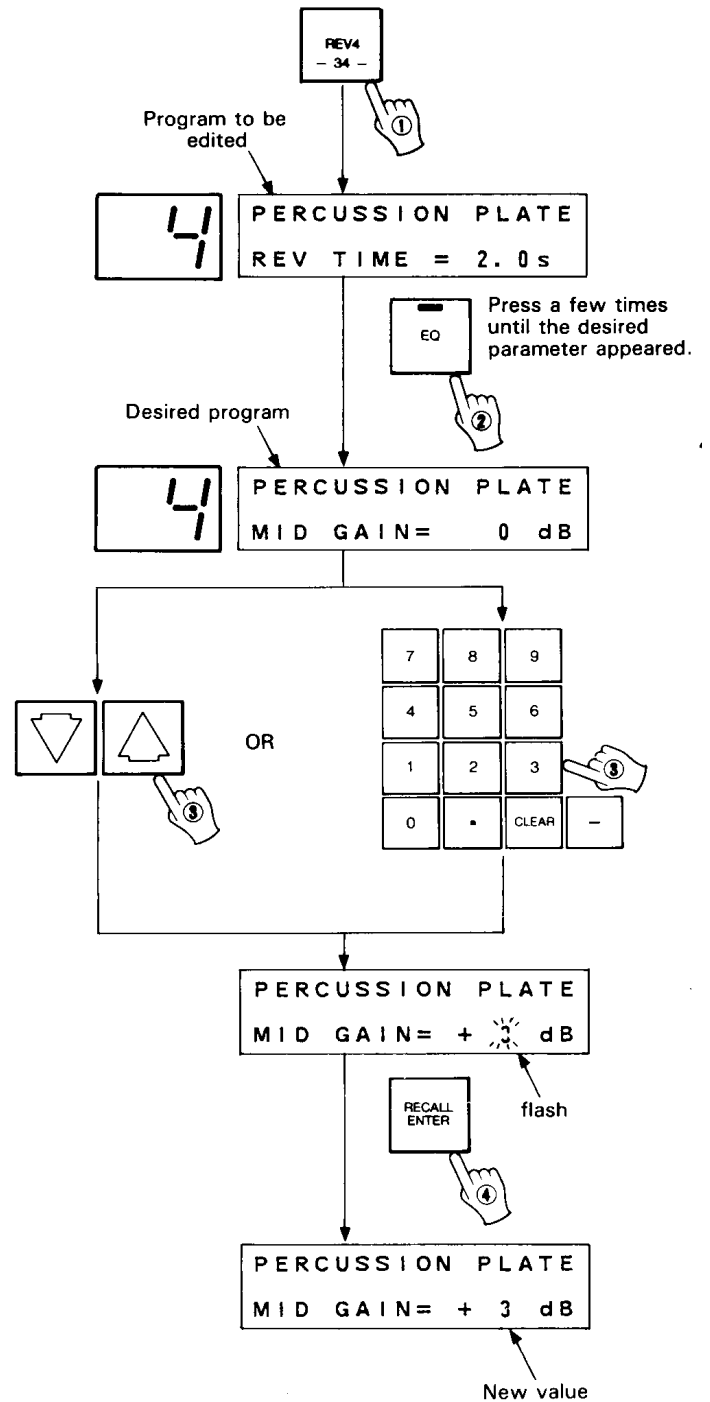

STORING EFFECTS

If a mistake is made entering a value using the Numeric/Editing keys, press the CLEAR key and enter the value again.

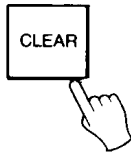

* Some parameters cannot be changed using the Numeric/Editing keys.

In this way you can go through and edit any number of the parameters to create the sound you want. If, however, you select and recall a new program without first storing your edited parameters in a memory location between 31 and 90, any changes you have made will be lost and will have to be re-programmed. If you want to keep an edited program, use the STORE operation described below.

In order to store an edited effect for later recall you need to do the following:

- ① After editing the effect press the MEMORY key.
- ② Select a memory location between 31 and 90 by using Numeric/Editing keys.
Do not recall the selected memory location.
- ③ Press the STORE key to store the edited effect in the selected memory location. The "MEMORY STORE" message will be displayed on the LCD. The title of the effect stored will appear on the LCD (this may later be edited to create your own effect title using the UTILITY mode TITLE EDIT function). The LED memory number display will stop flashing the stored memory location will become the active effect.

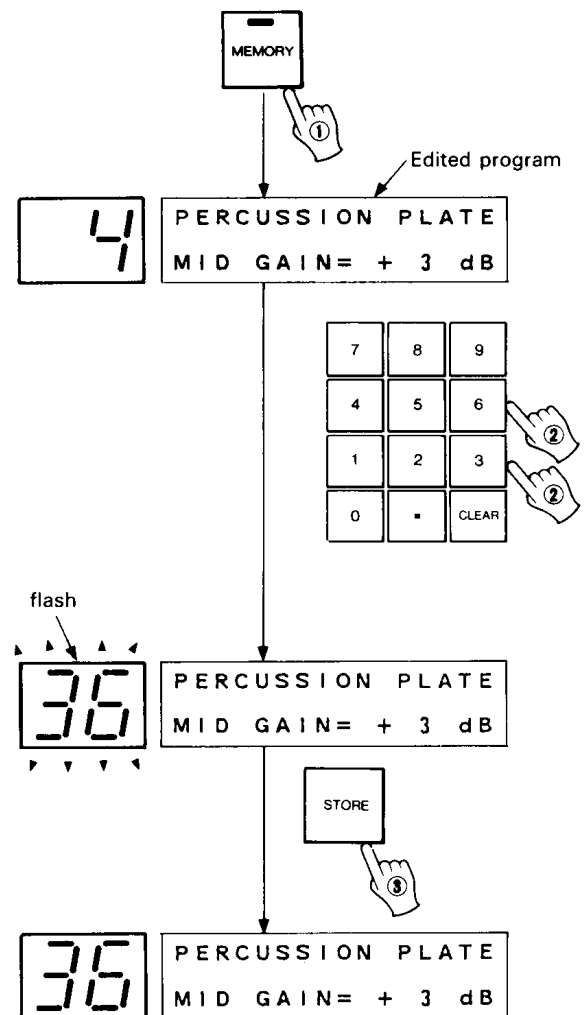

NOTE: You CANNOT store edited data to memory locations 1 through 30 or 91 through 99. If you attempt to do this the LCD will show

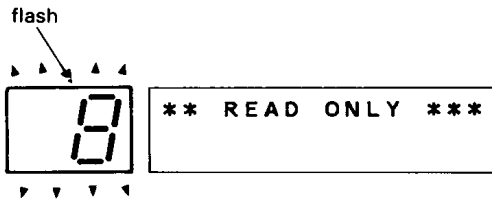

NOTE: Once an effect has been stored in a memory location between 31 and 90, its parameters can be further edited in the new memory location. Such changes will be lost if a different effect is selected and recalled, however, unless the STORE function is used to store the changes. Changes may be stored to the current memory location number (31–90) simply by pressing the STORE key.

3: DESCRIPTIONS OF PROGRAM TYPES & PARAMETERS

The REV5 effect programs are basically divided into 5 categories: reverb type programs, early reflection type programs, delay & echo type programs, modulation type programs and pitch change programs. The reverb type programs, as their name implies, are full reverb effects that accurately simulate reverberation occurring in live acoustic environments. The early reflection programs concentrate on providing precise control of the the early, less-dense series of reflections that precede the extremely dense reflections of subsequent reverberation. The early reflection category is further divided into two sub-categories—E/R 1 and E/R 2. E/R 1 programs have a denser reflection pattern than E/R 2 types. The delay & echo category includes some straightforward but high-quality stereo delay and echo effects, while the modulation category includes chorus, phasing, flanging, and automatic panning programs. Three different pitch change programs are provided, each providing a different combination of parameters. In this section, we'll look first at the parameters which are provided for all programs, and then at the parameters which apply to specific program categories. Refer to the "ROM CONTENTS AND CONTROLLABLE PARAMETERS" chart on page 56 for a complete listing of the parameters available for each program.

PARAMETERS PROVIDED FOR ALL PROGRAMS

LEVEL PARAMETERS (Accessed via LEVEL key)

Effect/Direct Signal Balance (BALANCE):

0—100%

This parameter adjusts the balance between the direct sound and effect signals. At 100% only the effect sound is delivered from the REV5 outputs, while at 0% only the direct sound is out put. At a setting of 50%, the direct and effect sounds are out-put in approximately equal proportions.

Effect Output Level (OUT LVL): 0—200%

This parameter sets the overall output level of the effect program. This is particularly handy for matching levels between different effects.

Output Phase Invert (OUT PHASE): OFF, ON

When this parameter is OFF, the phase of L and R outputs is equal. When ON, the phase of the R channel output is inverted in relation to the L channel.

INITIAL DELAY PARAMETER (Accessed via INITIAL DELAY key)

Initial Delay (INI DLY): 0.1—1000.0 ms

This represents the time delay between the direct sound of an instrument in a concert hall and the first of the many reflections that make up reverberation. In non-reverb effects, initial delay produces an offset between the direct sound and the beginning of the effect.

1ST REFLECTION PARAMETERS (Accessed via 1ST REF key)

Center Channel Delay (Cch DLY): 0.1—1000.0 ms

Left Channel Delay (Lch DLY): 0.1—1000.0 ms

Right Channel Delay (Rch DLY): 0.1—1000.0 ms

In a naturally reverberant environment, a number of isolated reflections will be heard before the dense, individually indistinguishable reverb reflections begin. These parameters permit creating separate "1st reflections" at the center, left and right of the stereo sound field, thus simulating the 3-dimensional reflections encountered in a live situation.

Center Channel Level (Cch LVL): 0—100%

Left Channel Level (Lch LVL): 0—100%

Right Channel Level (Rch LVL): 0—100%

These parameters individually set the levels of the center, left and right channel 1st reflections.

EQ PARAMETERS
(Accessed via EQ key)

Please note that the EQ ON key must be ON (its LED must be lit) for the EQ parameters to have an effect on the currently selected program.

Low EQ Peaking or Shelving Response
(LOW EQ.): PEAK, SHLV

High EQ Peaking or Shelving Response
(HI EQ.): PEAK, SHLV

These parameters, provided only for the high and low bands, determine whether the corresponding band has a peaking or shelving filter response.

Low EQ Frequency (LOW FRQ.): 32 Hz—2.2 kHz

Midrange EQ Frequency (MID FRQ.): 250 Hz—5.6 kHz

High EQ Frequency (HI FRQ.): 500 Hz—16 kHz

These parameters determine the center frequency for equalization in the corresponding band. In high or low bands set to the shelving mode, these parameters represent the cutoff frequencies rather than the center frequencies.

Low EQ Gain (LOW GAIN): -15—+15 dB

Midrange EQ Gain (MID GAIN): -15—+15 dB

High EQ Gain (HI GAIN): -15—+15 dB

These parameters determine the amount of boost or cut applied to the corresponding EQ band.

Low EQ Bandwidth (LOW Q): 0.1—5.0
(PEAK mode only)

Middle EQ Bandwidth (MID Q): 0.1—5.0

High EQ Bandwidth (HI Q): 0.1—5.0
(PEAK mode only)

These parameters determine the bandwidth of the corresponding EQ band. A setting of 0.1 produces the narrowest bandwidth (sharpest response), and the maximum setting of 5.0 produces the widest bandwidth (broadest response). Note that the "Q" parameters for the low and high bands only function when the corresponding band is set to the PEAK mode.

REVERB TYPE PROGRAMS

1. LARGE HALL

2. SMALL HALL

3. VOCAL PLATE

4. PERCUSSION PLATE

16. SPRING

17. ECHO ROOM

18. STRINGS

22. SNARE

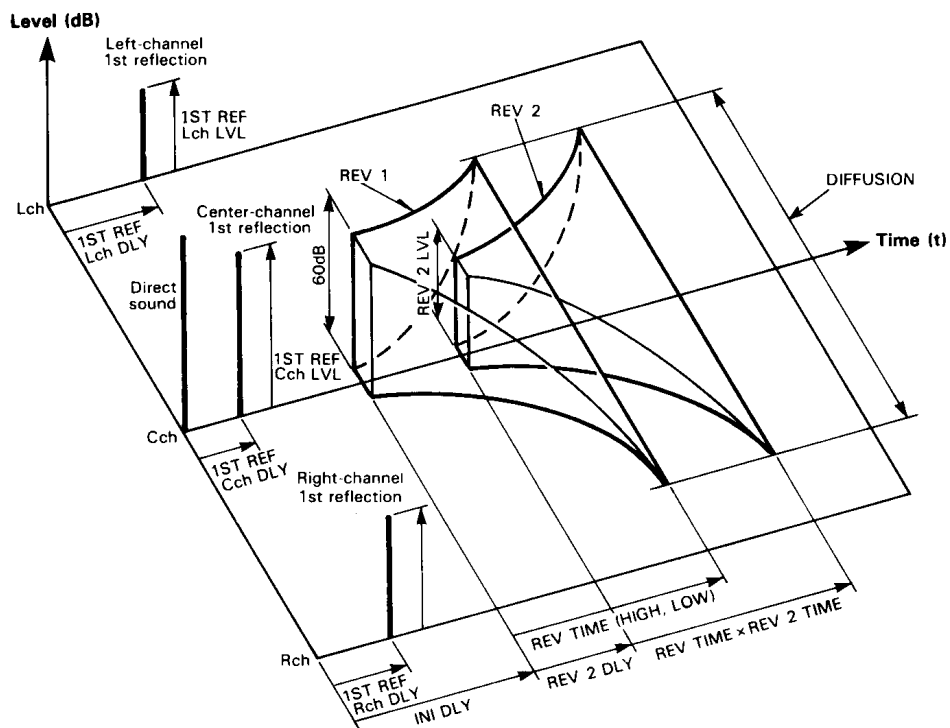

PARAMETERS ACCESSED BY THE PARAMETER KEY

Reverb Time (REV TIME): 0.3–99.0 s

The length of time it takes for the level of reverberation at 1 kHz to decrease by 60 dB—virtually to silence. In a live setting, this depends on several factors: room size, room shape, type of reflective surfaces, and others.

High Frequency Reverb Time Ratio (HIGH):

× 0.1 – × 1.0

Low Frequency Reverb Time Ratio (LOW):

× 0.1 – × 2.4

Natural reverberation varies according to the frequency of the sound. The higher the frequency, the more sound tends to be absorbed by walls, furnishings and even air. These two parameters allow alteration of the high-frequency and low-frequency reverb times in relation to the overall reverb time.

Diffusion (DIFFUSION): 0–10, 0–5

(2 SMALL HALL ONLY)

The complexity of the many reflections that make up reverberation varies according to the shape of the room and its contents. In the REV5 the term "diffusion" refers to the complexity of these reflections. If the DIFFUSION parameter is set to "0," minimum complexity and therefore a clearer, more straightforward reverb effect is produced. As the DIFFUSION value is increased, the complexity of the reflections increases producing a thicker, richer sound.

PARAMETERS ACCESSED BY THE INT PARAM KEY

Early Reflection/Reverb Balance (ER/REV BAL):

0–100%

This parameter determines the level balance between the early-reflection portion and final reverberation portion of the reverb sound. At 100% only the early-reflection sound will be produced. At 0% only the final reverberation sound will be produced. A setting of about 50% produces both the early-reflection and final reverberation sounds at equal level.

Density (DENSITY): 1–4

This parameter determines the density of the reverb reflections (i.e. the average amount of time between reflections). A setting of 1 produces minimum reverb density for a more spacious sound, while a setting of 4 produces the most dense, "tightest" reverberation.

Low-pass Filter Frequency (LPF FRQ.):

1.0 kHz–16 kHz, THRU

Permits rolling off the high-frequency content of the reverb signal above the set frequency. The LPF is OFF when set to THRU.

Space Modulation (SPACE MOD): 0–10

This parameter creates a periodic variation in the reverb sound which simulates the effect which occurs naturally due to interference between reflections in a live acoustic environment. A setting of 0 produces no space modulation while a setting of 10 produces maximum space modulation.

Secondary Reverb Time (REV2 TIME): × 0.1 – × 10.0

Secondary Reverb Delay (REV2 DLY): 0.0–500.0 ms

Secondary Reverb Level (REV2 LVL): 0–100%

These three parameters control a second reverb sound which appears along with the primary reverberation, thus significantly thickening the overall reverberation effect.

REV2 TIME is set as a multiple of the primary reverb time. A setting of 1, therefore, produces secondary reverberation of the same duration as the primary reverb sound. A setting of 0.1 produces secondary reverberation only 1/10th as long as the primary reverb (e.g. if the primary REV TIME parameter is set to 10 seconds, the secondary reverb time will be 1 second). A setting of 10 produces secondary reverberation 10 times as long as the primary reverberation.

The REV2 DELAY parameter produces a delay between the beginning of the primary reverberation and the secondary reverberation, and the REV2 LVL parameter sets the level of the secondary reverberation in relation to the primary reverberation.

Gate Level (GATE LVL): 0–100%

This sets the threshold level of the program's internal noise gate. GATE LVL should be set so that noise is eliminated when no source signal is present, and the attack and decay portions of the source signal are passed as naturally as possible without abrupt transitions.

23. REVERB & GATE

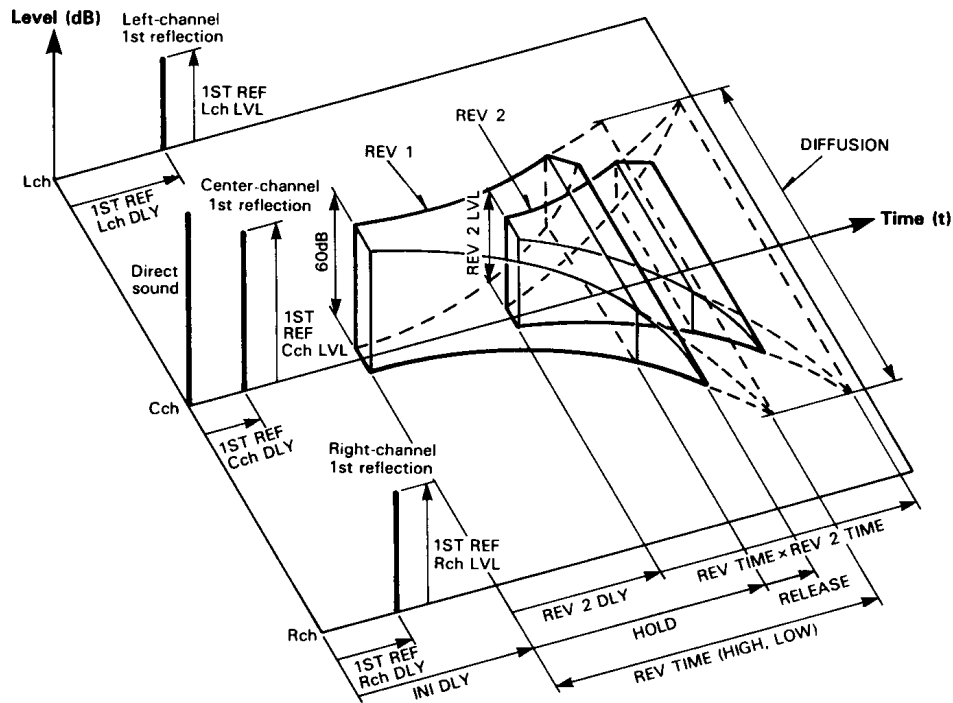

In addition to the parameters described above, the REVERB & GATE program has the following gate parameters.

PARAMETER ACCESSED BY THE PARAMETER KEY

Trigger Level (TRG LEVEL): 1 – 100

Determines the level of the input signal required to trigger "opening" of the gate. At 99% only very high-level input signals will trigger the gate, while at 1% even the tiniest input signal will trigger the gate.

Trigger Delay (TRG DLY): 0.1 – 1000.0 ms

Produces a delay between the time at which the gate is triggered and that at which it actually opens.

Hold Time (HOLD): 1 – 24000 ms

Determines how long the gate stays open, allowing the signal to pass.

Release Time (RELEASE): 5 – 24000 ms

Determines how long it takes for the gate to close fully after the HOLD has ended.

MIDI Trigger (MIDI TRG.): OFF, ON

When this parameter is turned ON, a KEY ON EVENT message from an external MIDI keyboard can be used to trigger the gate. A KEY ON EVENT message is transmitted whenever a note on a MIDI keyboard is played.

EARLY REFLECTION 1 AND 2 TYPE PROGRAMS

5. EARLY REF. 1

6. EARLY REF. 2

19. ELECTRIC BASS A

20. ELECTRIC BASS B

21. KICK

24. REVERSE GATE

25. REHEARSAL ROOM

30. LIVE REFERENCE

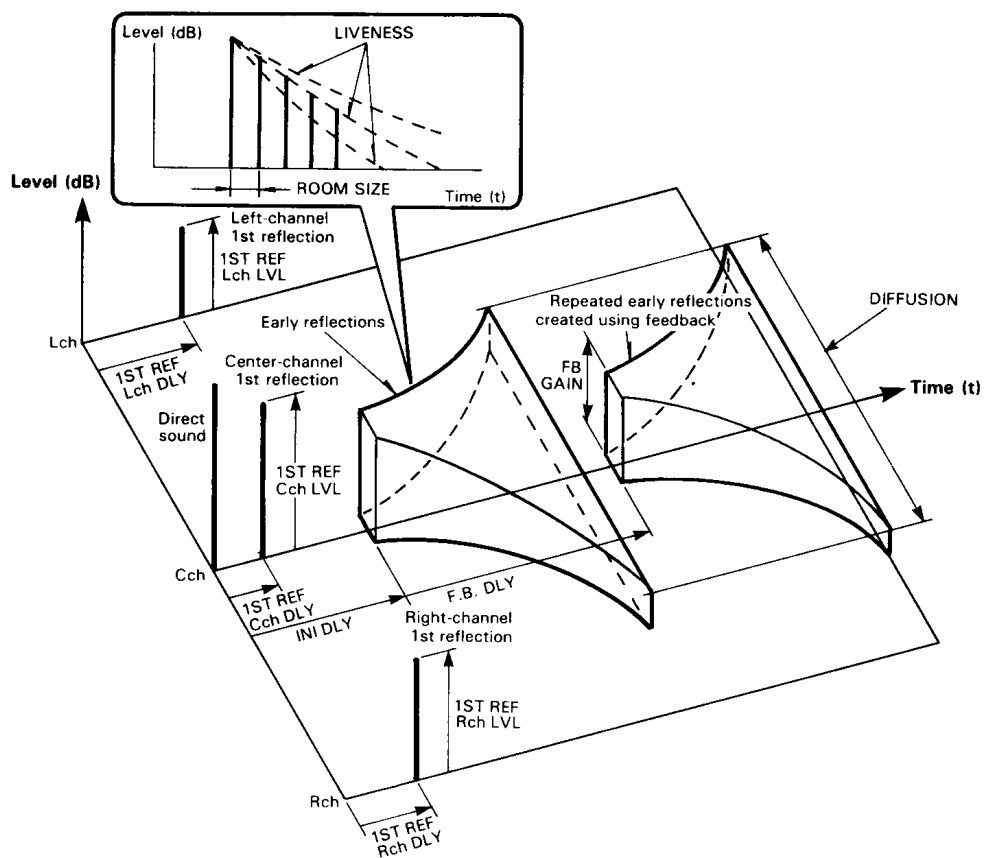

PARAMETERS ACCESSED BY THE PARAMETER KEY

Early Reflection Mode (MODE): S-HALL, L-HALL, RANDOM, REVERSE, PLATE, SPRING, PAN-A, PAN-B

The MODE parameter selects one of six different patterns of early reflections. S-HALL produces a typical grouping of early reflections that would occur in a performing environment such as a small hall. L-HALL simulates the early reflection pattern of a larger hall. RANDOM produces an irregular series of reflections that could not occur naturally. REVERSE generates a series of reflections that increase in level—like the effect produced by playing a recorded reverberation sound backwards. PLATE produces a typical grouping of reflections that would occur in a plate reverb unit, and SPRING produces the same for spring type reverb unit. PAN-A and PAN-B pan the early-reflection sound across the stereo sound field in different ways. PAN-A pans in only one direction—either right to left or left to right, while PAN-B pans back and forth in both directions.

Please note that the MODE parameter for the REHEARSAL ROOM program has PIANO, ORGAN, BRASS and GUITAR settings rather than those given above. These are early-reflection patterns specifically designed to bring out the best qualities of the instruments after which they are named.

Liveness (LIVENESS): 0–10

“Liveness” refers to the rate at which the reflected sounds fade. An acoustically “dead” room is simulated by setting this parameter to zero. Increasing the value of this parameter creates an increasingly “live” sound, simulating an increasing area of reflective surfaces in the room.

In the case of PAN-A and PAN-B a setting of “0” causes panning from left to right, and a setting of “10” causes panning in the opposite direction. A setting of “5” produces no pan effect.

Room Size (ROOM SIZE): 0.1–25.0

This parameter sets the time intervals between the early reflections—a feature of natural early reflections which is directly proportional to the size of the room.

Diffusion (DIFFUSION): 0–10

The complexity of the many reflections that make up reverberation varies according to the shape of the room and its contents. In the REV5 the term “diffusion” refers to the complexity of these reflections. If the DIFFUSION parameter is set to “0” minimum complexity and therefore a clearer, more straightforward reverb effect is produced. As the DIFFUSION value is increased, the complexity of the reflections increases producing a thicker, richer sound.

PARAMETERS ACCESSED BY THE INT PARAM KEY

Number of Early Reflections (ER NUMBER): 1–34

This parameter directly sets the number of early reflections produced from 1 to 34.

Density (DENSITY): 1, 2 (PROGRAM No. 6, 20, 24, 30 ONLY)

This parameter determines the density of the reverb reflections (i.e. the average amount of time between reflections). A setting of 1 produces minimum reverb density for a more spacious sound, while a setting of 2 produces the most dense, “tightest” reverberation.

Low-pass Filter Frequency (LPF FRQ.):

1.0 kHz–16 kHz, THRU

Permits rolling off the high-frequency content of the reverb signal above the set frequency. The LPF is OFF when set to THRU.

Space Modulation (SPACE MOD): 0–10 (PROGRAM No. 6, 20, 24, 30 ONLY)

Feedback Delay (FB DLY): 0.1–1400.0 ms

Feedback Gain (FB GAIN): 0–99%

Feedback High-frequency Ratio (FB HIGH):

× 0.1 – × 1.0

The feedback parameters permit thickening and/or extending the early reflection sound. Feedback causes the early reflections to generate more early reflections of themselves, thus the FB GAIN parameter determines how many times (for how long) the early reflections are repeated.

The FB DLY parameter sets a delay time between the beginning of the original early-reflections and the first of the repeats caused by feedback. Shorter FB DLY times simply thicken the early-reflection sound, while longer FB DLY times can create extended or repeated early reflection effects.

FB HIGH determines how much of the high-frequency content of the original early reflections is fed back. The lowest the setting, the less of the original high frequencies are fed back. This causes a gradual decrease in high frequency content at each repeat.

Gate Level (GATE LVL): 0 – 100%

This sets the threshold level of the program's internal noise gate. GATE LVL should be set so that noise is eliminated when no source signal is present, and the attack and decay portions of the source signal are passed as naturally as possible without abrupt transitions.

Early Reflection Mode Chart

This chart shows the exact number and type of reflections created by the REV5 for each mode selected with EARLY REFLECTION 1 OR 2 type programs.

ROOM SIZE : 1.0

S-HALL

ROOM SIZE : 4.0

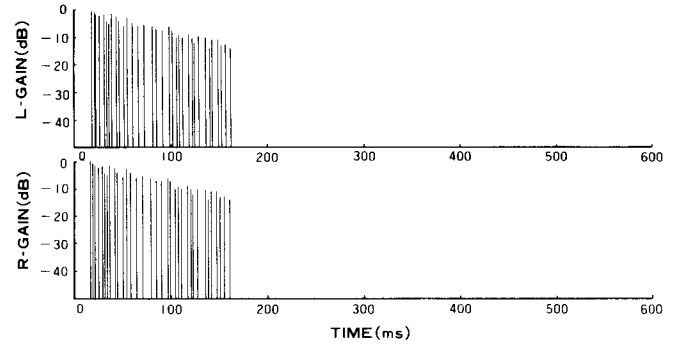
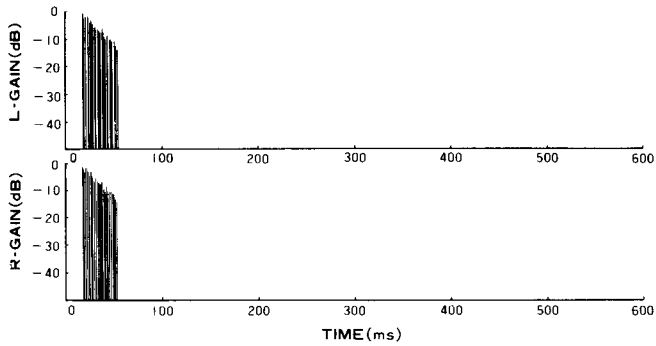

ROOM SIZE : 1.0

L-HALL

ROOM SIZE : 4.0

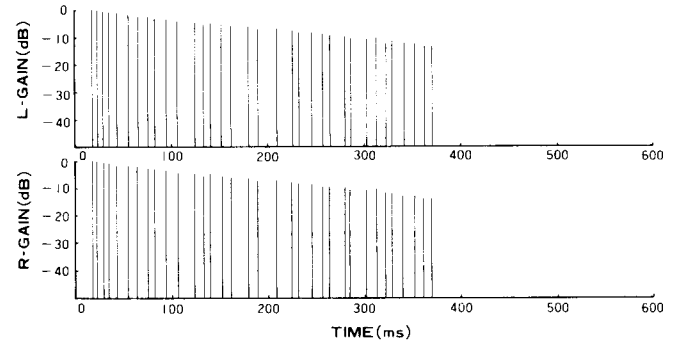
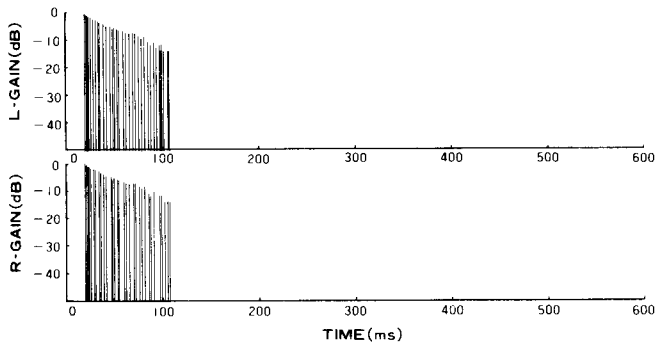

ROOM SIZE : 1.0

RANDOM

ROOM SIZE : 4.0

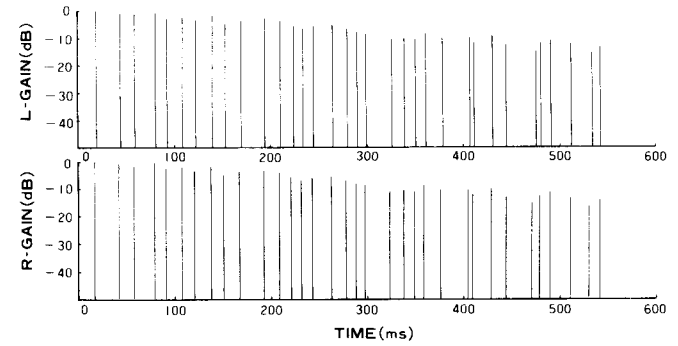
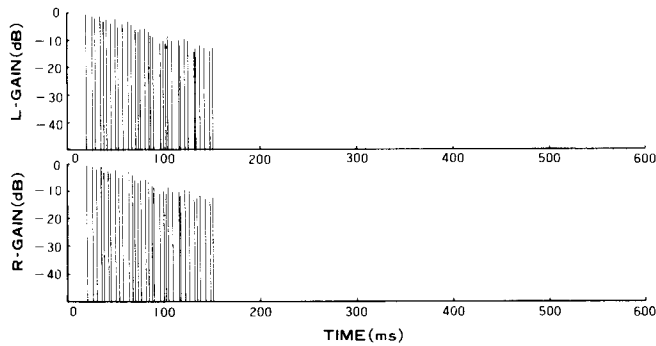

ROOM SIZE : 1.0

REVERSE

ROOM SIZE : 4.0

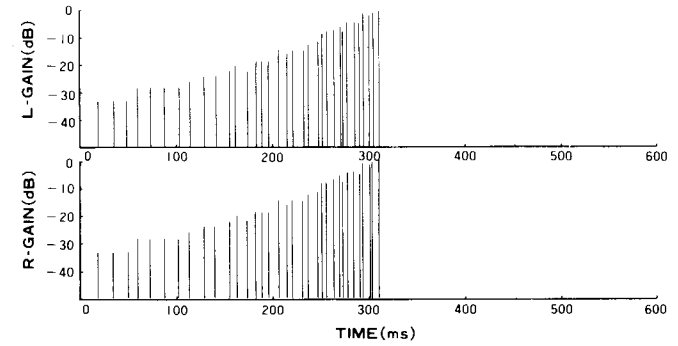
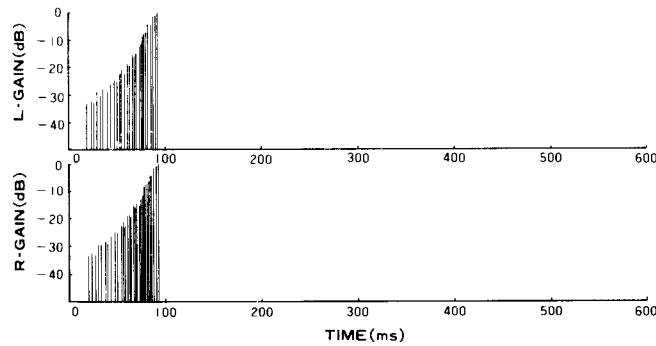

Room Size Chart

This chart shows the relationship between the Room Size parameter for each mode selected with EARLY REFLECTION 1 OR 2 type programs, and the size of actual rooms.

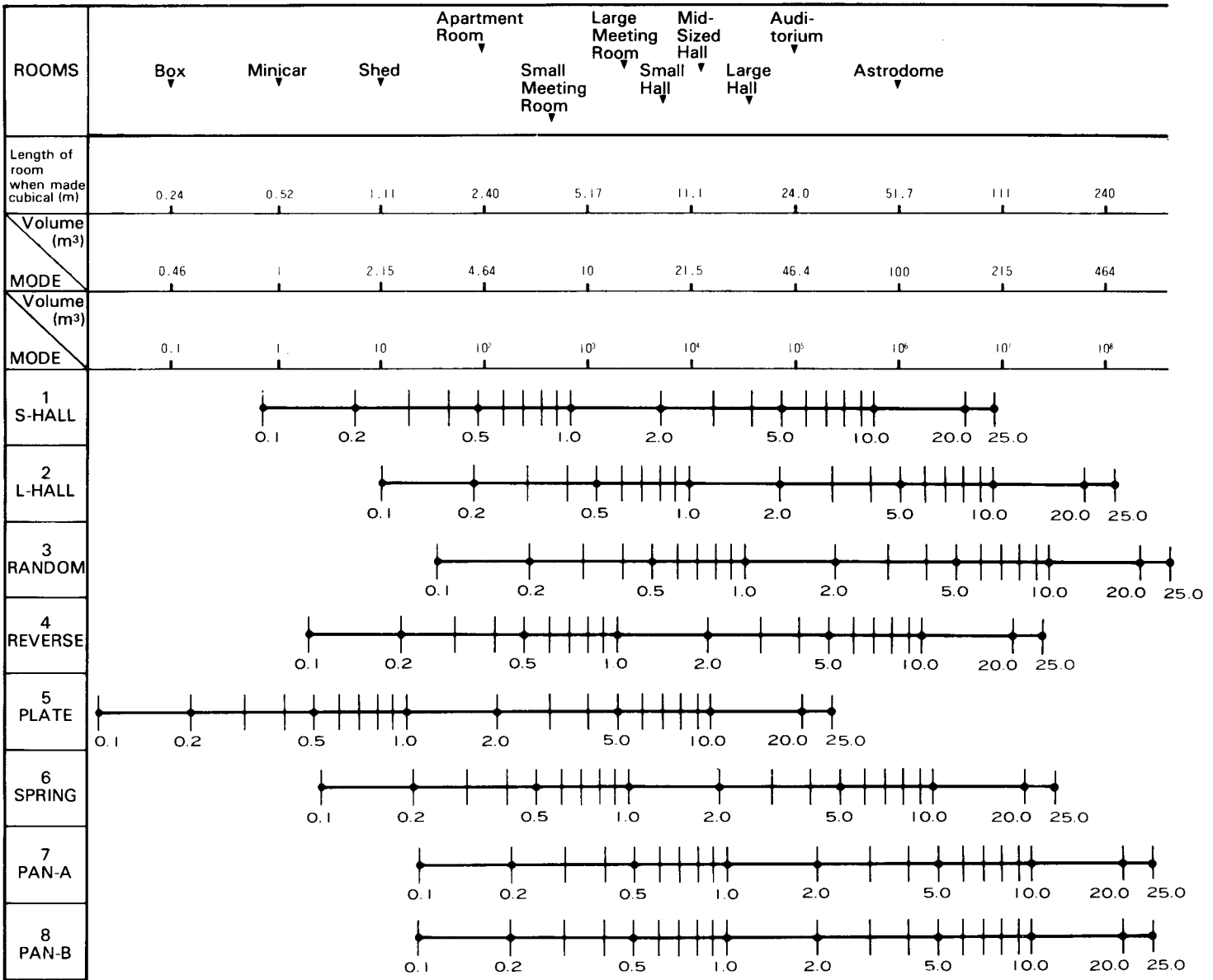

DELAY & ECHO TYPE PROGRAMS

7. DELAY L, R

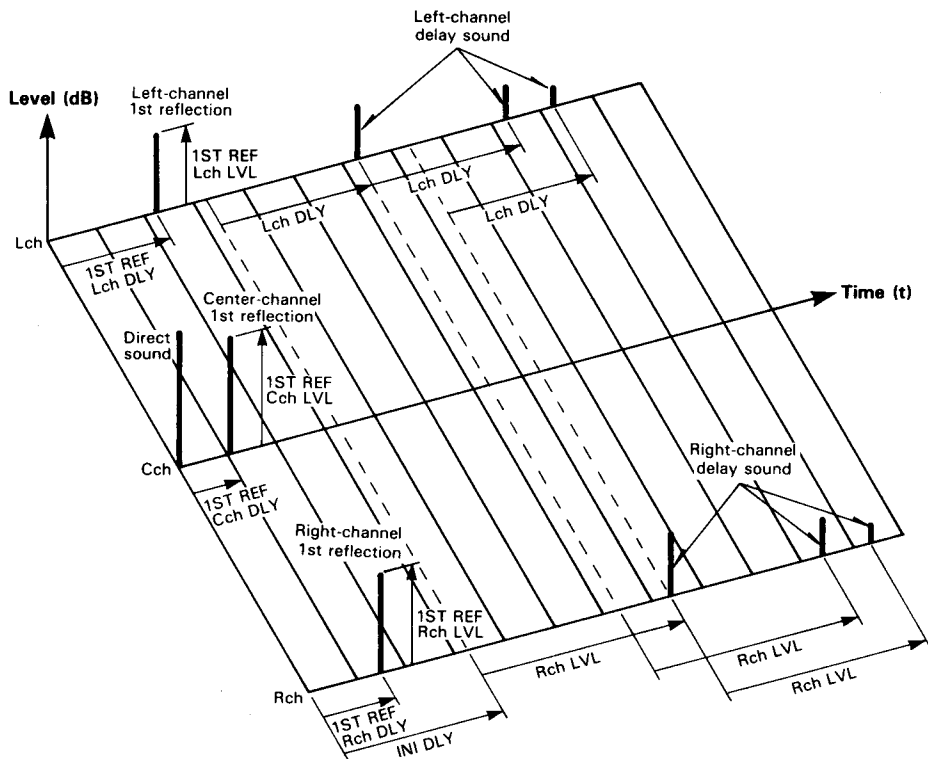

PARAMETERS ACCESSED BY THE PARAMETER KEY

Left Channel Delay (Lch DLY): 0.1–2900.0 ms

Right Channel Delay (Rch DLY): 0.1–2900.0 ms

These parameters individually set the time between the direct sound of the instrument and the first repeat heard from the left and right channels.

Left Channel Feedback Gain (Lch F.B): –99– +99%

**Right Channel Feedback Gain (Rch F.B):
–99– +99%**

Individually set the amount of the left or right channel delay signal fed back to the input of the processor. The higher the feedback gain setting, the greater the number of delayed repeats produced for the corresponding channel.

High Frequency Feedback (HIGH): × 0.1– × 1.0

Controls feedback in the high-frequency range. The high-frequency feedback is reduced as the value of this parameter is decreased.

PARAMETERS ACCESSED BY THE INT PARAM KEY

Low-pass Filter Frequency (LPF FRQ.): 1.0 kHz—16 kHz, THRU

Permits rolling off the high-frequency content of the reverb signal above the set frequency. The LPF is OFF when set to THRU.

Gate Level (GATE LVL): 0—100%

This sets the threshold level of the program's internal noise gate. GATE LVL should be set so that noise is eliminated when no source signal is present, and the attack and decay portions of the source signal are passed as naturally as possible without abrupt transitions.

8. STEREO ECHO

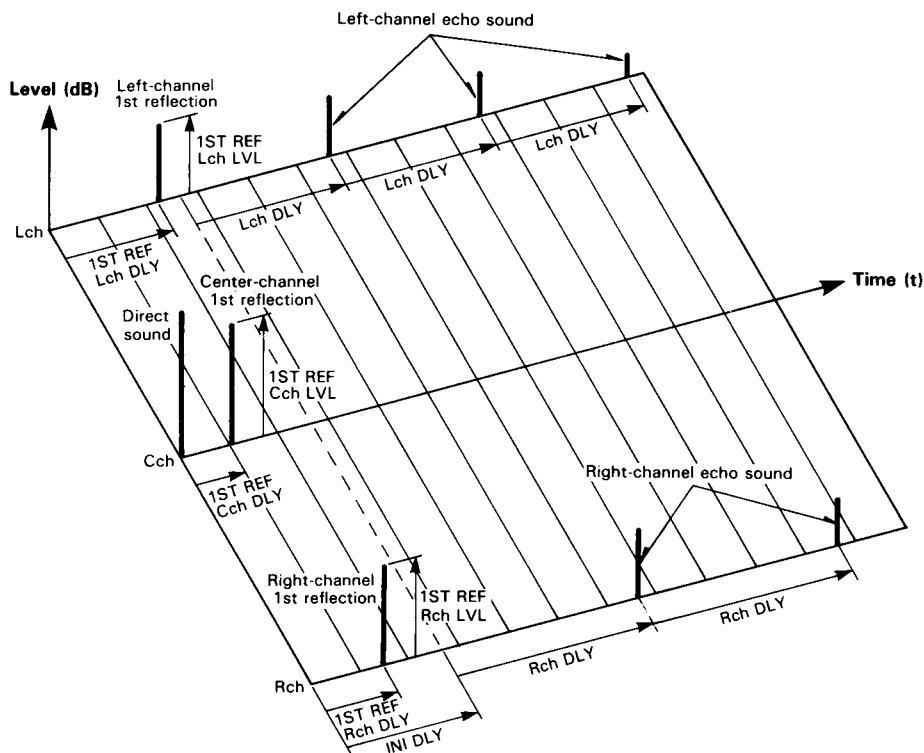

PARAMETERS ACCESSED BY THE PARAMETER KEY

Left Channel Delay (Lch DLY): 0.1—1400.0 ms

Right Channel Delay (Rch DLY): 0.1—1400.0 ms

These parameters individual set the time between the direct sound of the instrument and the first repeat heard from the left and right channels.

Left Channel Feedback Gain (Lch F.B): -99—+99%

Right Channel Feedback Gain (Rch F.B): -99—+99%

Individually set the amount of the left or right channel delay signal fed back to the input of the processor. The higher the feedback gain setting, the greater the number of delayed repeats produced for the corresponding channel.

High Frequency Feedback (HIGH): × 0.1—× 1.0

PARAMETERS ACCESSED BY INT PARAM KEY

Low-pass Filter Frequency (LPF FRQ.): 1.0 kHz—16 kHz, THRU

Permits rolling off the high-frequency content of the reverb signal above the set frequency. The LPF is OFF when set to THRU.

Gate Level (GATE LVL): 0—100%

This sets the threshold level of the programs internal noise gate. GATE LVL should be set so that noise is eliminated when no source signal is present, and the attack and decay portions of the source signal are passed as naturally as possible without abrupt transitions.

MODULATION TYPE PROGRAMS

9. STEREO FLANGE

10. REVERB FLANGE

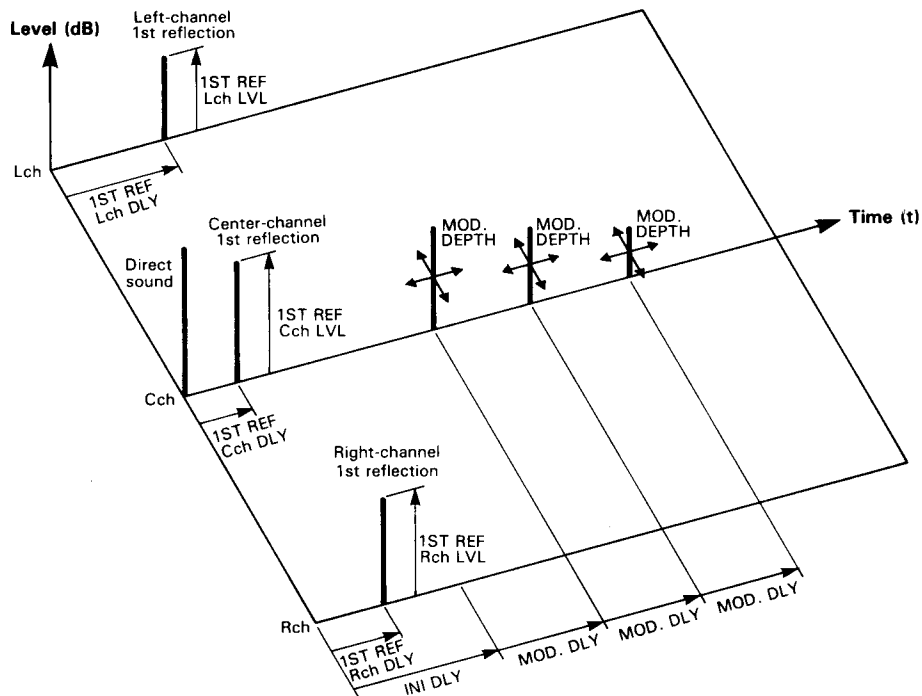

PARAMETERS ACCESSED BY THE PARAMETER KEY

Please note that REVERB FLANGE has the same REV TIME, HIGH, LOW and DIFFUSION parameters as the reverb type effects, in addition to the MOD FRQ, MOD DEPTH and MOD DELAY parameters listed below.

Modulation Frequency (MOD. FRQ): 0.1–40.0 Hz

Sets the speed of modulation, and hence the rate at which the effect varies.

Modulation Depth (MOD. DEPTH): 0–100%

Sets the amount of delay time variation, thus adjusting the depth of the effect.

Modulation Delay (MOD. DLY): 0.1 –100.0 ms (STEREO FLANGE), 0.1–30.0 ms (REVERB FLANGE)

This sets the basic delay time from the initial direct sound to the beginning of the flange effect.

Feedback Gain (F.B. GAIN): 0–99%

Determines the amount of flange signal which is fed back to the input of the processor for further modulation. More feedback increases the overall complexity, "strength" and decay time of the effect.

PARAMETERS ACCESSED BY THE INT PARAM KEY

Please note that the REVERB FLANGE program has the same internal parameters as the reverb type programs. All other modulation type programs have the two internal parameters described below.

Low-pass Filter Frequency (LPF FRQ.):

1.0 kHz–16 kHz, THRU

Permits rolling off the high-frequency content of the reverb signal above the set frequency. The LPF is OFF when set to THRU.

Gate Level (GATE LVL): 0–100%

This sets the threshold level of the program's internal notice gate. GATE LVL should be set so that noise is eliminated when no source signal is present, and the attack and decay portions of the source signal are passed as naturally as possible without abrupt transitions.

11. CHORUS A

12. CHORUS B

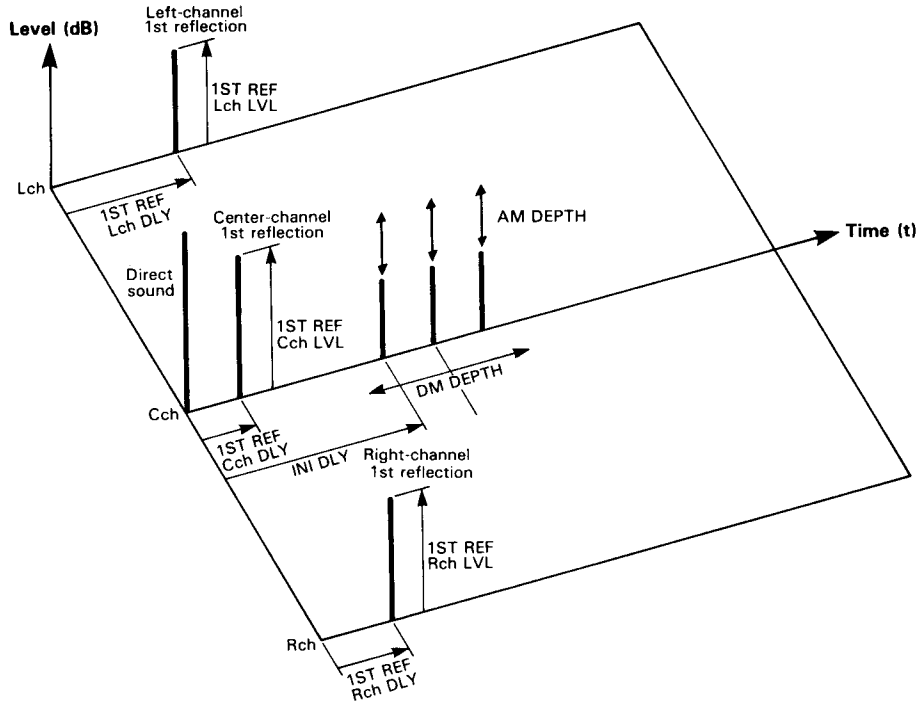

PARAMETERS ACCESSED BY THE PARAMETER KEY

Modulation Frequency (MOD. FRQ): 0.1–40.0 Hz

Sets the speed at which the effect varies.

Delay Modulation Depth (DM DEPTH): 0–100%

This sets the amount by which the delay time of one delay signal is varied in relation to the other, and thus the depth of the CHORUS effect.

Amplitude Modulation Depth (AM DEPTH): 0–100%

Sets the amount by which the amplitude (level) of the input signal is varied.

PARAMETERS ACCESSED BY THE INT PARAM KEY

Low-pass Filter Frequency (LPF FRQ.):

1.0 kHz–16 kHz, THRU

Permits rolling off the high-frequency content of the reverb signal above the set frequency. The LPF is OFF when set to THRU.

Gate Level (GATE LVL): 0–100%

This sets the threshold level of the program's internal noise gate. GATE LVL should be set so that noise is eliminated when no source signal is present, and the attack and decay portions of the source signal are passed as naturally as possible without abrupt transitions.

13. STEREO PHASING

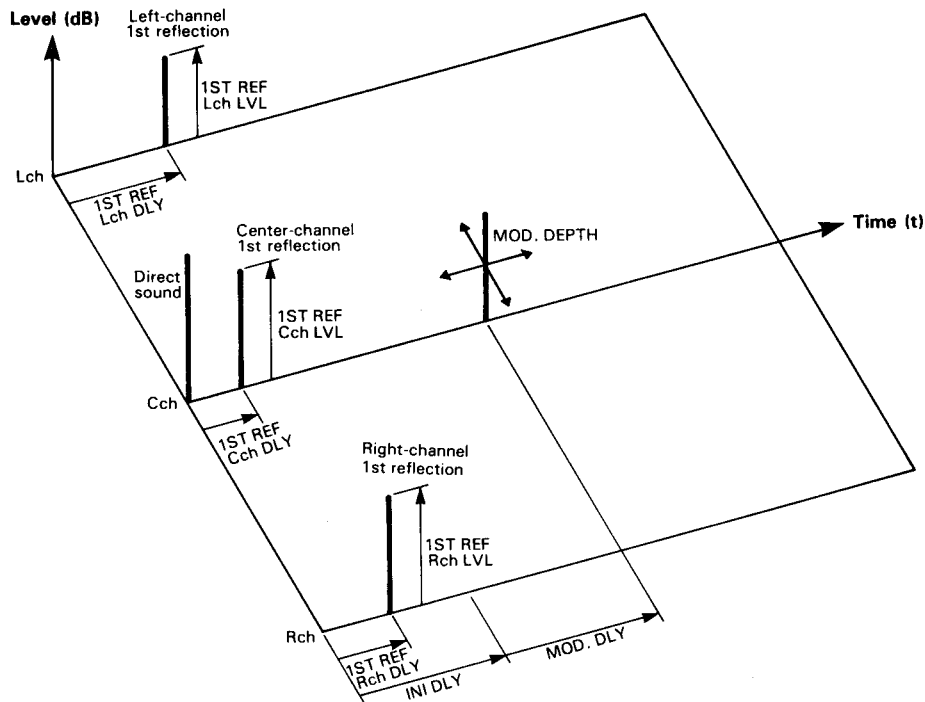

PARAMETERS ACCESSED BY THE PARAMETER KEY

Modulation Frequency (MOD. FRQ): 0.1 Hz—40.0 Hz

Sets the speed of modulation, and hence the rate at which the effect varies.

Modulation Depth (MOD. DEPTH): 0—100%

Sets the amount of delay time variation, thus adjusting the depth of the effect.

Modulation Delay (MOD. DLY): 0.1—5.0 ms

This sets the basic delay time from the initial direct sound to the beginning of the flange effect.

PARAMETERS ACCESSED BY THE INT PARAM KEY

Low-pass Filter Frequency (LPF FRQ.): 1.0 kHz—16 kHz, THRU

Permits rolling off the high-frequency content of the reverb signal above the set frequency. The LPF is OFF when set to THRU.

Gate Level (GATE LVL): 0—100%

This sets the threshold level of the program's internal noise gate. GATE LVL should be set so that noise is eliminated when no source signal is present, and the attack and decay portions of the source signal are passed as naturally as possible without abrupt transitions.

14. TREMOLO

15. SYMPHONIC

PARAMETER ACCESSED BY THE PARAMETER KEY

Modulation Frequency (MOD. FRQ): 0.1–40.0 Hz

Sets the speed of modulation, and hence the rate at which the effect varies.

Modulation Depth (MOD. DEPTH): 0–100%

Sets the amount of delay time variation, thus adjusting the depth of the effect.

PARAMETERS ACCESSED BY THE INT PARAM KEY

Low-pass Filter Frequency (LPF FRQ.):

1.0 kHz–16 kHz, THRU

Permits rolling off the high-frequency content of the reverb signal above the set frequency. The LPF is OFF when set to THRU.

Gate Level (GATE LVL): 0–100%

This sets the threshold level of the program's internal noise gate. GATE LVL should be set so that noise is eliminated when no source signal is present, and the attack and decay portions of the source signal are passed as naturally as possible without abrupt transitions.

PITCH CHANGE TYPE PROGRAMS

PROGRAM	PITCH CHANGE	FEEDBACK	MIDI PITCH CONTROL
PITCH CHANGE A	1 TONE	YES	YES
PITCH CHANGE B	2 TONES (CENTER)	NO	YES
PITCH CHANGE C	2 TONES (1 EACH IN L & R CH.)	NO	YES

26. PITCH CHANGE A

Example: Pitch shift set at "+ 1", a fairly high Feedback setting an input note of C3.

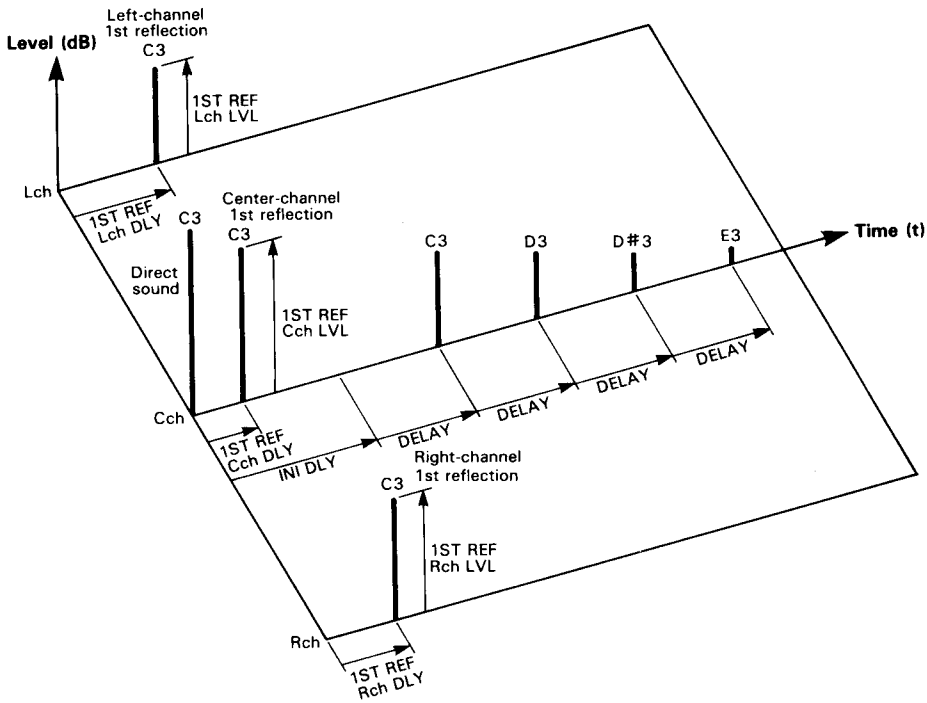

PARAMETERS ACCESSED BY THE PARAMETER KEY

Pitch Shift (PITCH): -12 - +12

Sets the degree of pitch change in semitone steps. +12 corresponds to an output pitch one octave higher than the input pitch, and -12 produces an output pitch one octave lower than the input pitch. An external MIDI keyboard can even be used to select the desired degree of pitch shift.

Fine Tuning (FINE): -100 - +100

Permits extremely fine pitch adjustment in one-cent steps.

Delay Time (DELAY): 0.1 - 400.0 ms

Sets the delay between the direct sound (input signal) and the pitch-shifted output signal.

Feedback Gain (F.B. GAIN): 0 - 99%

When this parameter is set to 0, only a single pitch-shifted sound is produced after the DELAY time has elapsed. As the value of this parameter is increased, however, more and more delayed repeats are produced, each pitch-shifted up or down from the previous repeat according to the setting of the PITCH parameter.

Base key (BASE KEY): OFF, C1—C6

This parameter sets the "BASE KEY" for an external MIDI synthesizer used to control the PITCH parameter (the MIDI OUT terminal of the synthesizer must be connected to the REV5 MIDI IN terminal, and the REV5 must be set to receive on the MIDI channel on which the synthesizer is transmitting). If, for example, the BASE KEY parameter is set to C4, pressing the C3 key on the synthesizer (C3 is one octave lower than C4) will set the pitch change value to -12. Pressing D4 on the keyboard would produce a pitch increase of one whole-tone (+2). If a key more than an octave higher or lower than the BASE KEY is pressed, the resultant pitch change setting will still be within the -12 to +12 range, as shown in the illustration below. If the BASE KEY parameter is set OFF, pitch cannot be controlled via the MIDI IN terminal.

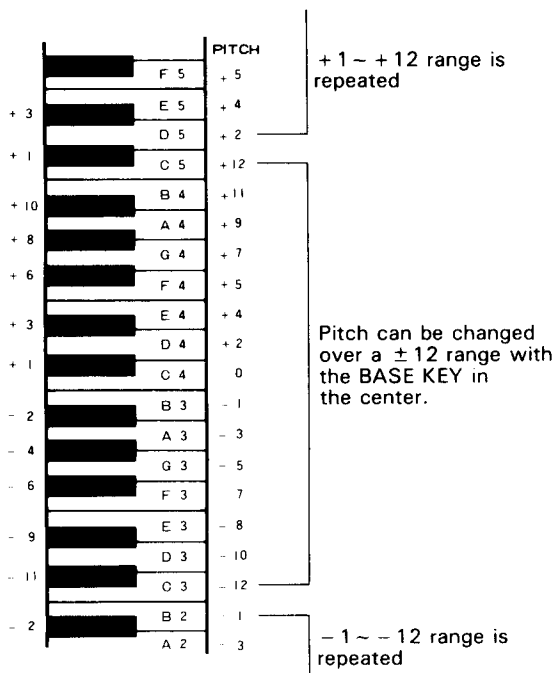

PARAMETERS ACCESSED BY THE INT PARAM KEY

Low-pass Filter Frequency (LPF FRQ.):

1.0 kHz—16 kHz, THRU

Permits rolling off the high-frequency content of the reverb signal above the set frequency. The LPF is OFF when set to THRU.

Gate Level (GATE LVL): 0—100%

This sets the threshold level of the program's internal noise gate. GATE LVL should be set so that noise is eliminated when no source signal is present, and the attack and decay portions of the source signal are passed as naturally as possible without abrupt transitions.

27. PITCH CHANGE B

Example: Pitch shift set at “+4” and “+7” with an input note of C3.

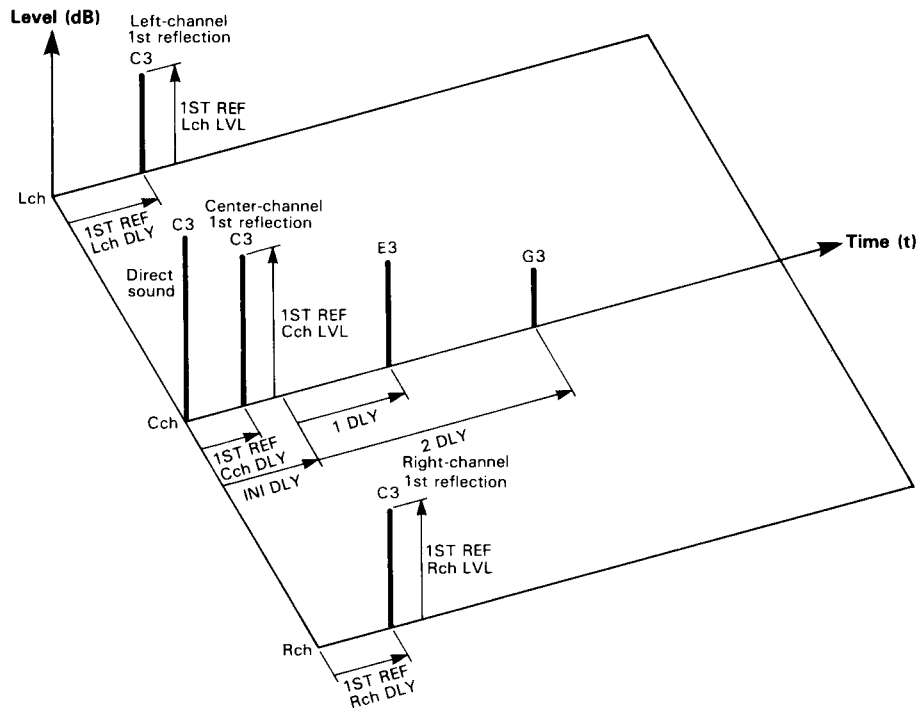

PITCH CHANGE B makes it possible to produce two independently pitch-shifted output notes in addition to the direct signal, so you can actually create three-part harmonies with a single input note. Both pitch-shifted notes appear at the center of the stereo sound field (i.e. they are output equally to the L and R OUTPUT jacks).

PARAMETERS ACCESSED BY THE PARAMETER KEY

1st Pitch Shift (1 PITCH): -12 - +12

Set the pitch of the first pitch-shifted note between one octave below (-12) and one octave above (+12) the input note.

1st Fine Tuning (1 FINE): -100 - +100

Permit fine tuning of the first pitch-shifted note in 1-cent steps.

1st Delay Time (1 DLY): 0.1 - 400.0 ms

Determines the time delay between input of the original note and output of the first pitch-shifted note.

2nd Pitch Shift (2 PITCH): -12 - +12

Set the pitch of the second pitch-shifted note between one octave below (-12) and one octave above (+12) the input note.

2nd Fine Tuning (2 FINE): -100 - +100

Permit fine tuning of the second pitch-shifted note in 1-cent steps.

2nd Delay Time (2 DLY): 0.1 - 400.0 ms

Determines the time delay between input of the original note and output of the second pitch-shifted note.

Base Key (BASE KEY): OFF, C1 - C6

Same as PITCH CHANGE A, above.

PARAMETERS ACCESSED BY THE INT PARAM KEY

Same as PITCH CHANGE A, above.

28. PITCH CHANGE C

Example: Lch pitch shift set at "+4," Rch pitch shift at "+7" and an input note of C3.

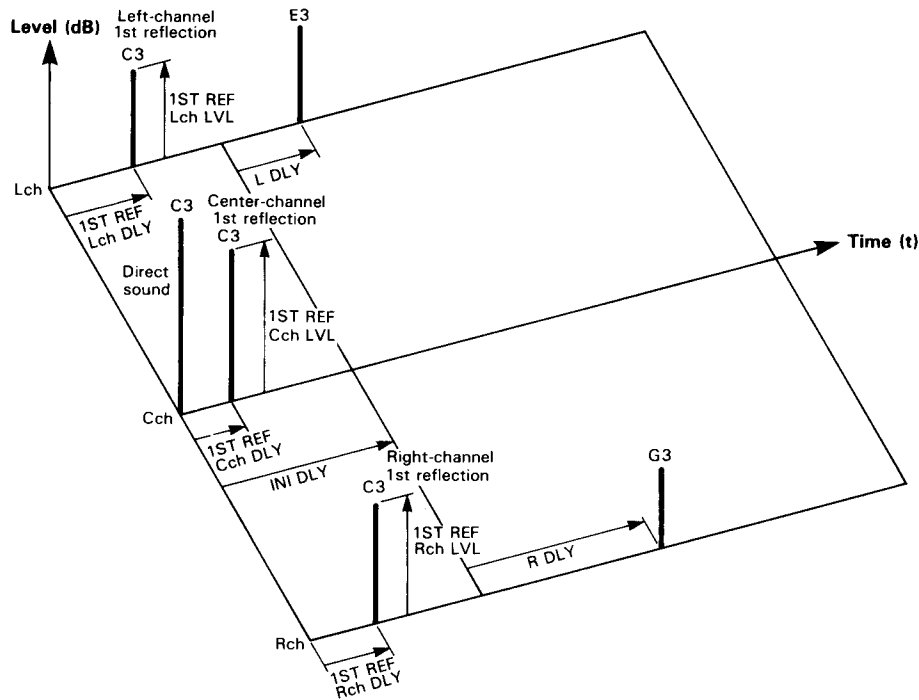

Like the PITCH CHANGE B program, PITCH CHANGE C produces 2 pitch-shifted notes in addition to the original input note. In this program, however, the two pitch-shifted notes are independently fed to the left and right channel outputs (the direct sound is positioned at the center of the stereo sound field) for a true stereo harmony effect.

PARAMETERS ACCESSED BY THE PARAMETER KEY

Left Pitch Shift (L PITCH): -12 - +12

Set the pitch of the left channel pitch-shifted note between one octave below (-12) and one octave above (+12) the input note.

Left Fine Tuning (L FINE): -100 - +100

Permit fine tuning of the left channel pitch-shifted note in 1-cent steps.

Left Delay Time (L DLY): 0.1 - 200.0 ms

Determine the time delay between input of the original note and output of the left channel pitch-shifted note.

Right Pitch Shift (R PITCH): -12 - +12

Set the pitch of the right channel pitch-shifted note between one octave below (-12) and one octave above (+12) the input note.

Right Fine Tuning (R FINE): -100 - +100

Permit fine tuning of the right channel pitch-shifted note in 1-cent steps.

Right Delay Time (R DLY): 0.1 - 200.0 ms

Determine the time delay between input of the original note and output of the right channel pitch-shifted note.

Base Key (BASE KEY): OFF, C1 - C6

Same as PITCH CHANGE A, above.

COMBINATION GATED PROGRAMS

PARAMETERS ACCESSED BY THE INT PARAM KEY

Same as PITCH CHANGE A, above.

29. PAN

PARAMETERS ACCESSED BY THE INT PARAM KEY

Pan Speed (PAN SPEED): 0.1–40.0 Hz

Sets the speed of the PAN effect (i.e. how rapidly the signal sweeps from channel to channel).

Pan Direction (DIRECTION): L→R, L←R, L↔R

Determines the direction in which the sound sweeps across the stereo sound field.

Pan Depth (DEPTH): 0–100%

Sets the degree of level variation produced by the PAN effect. The higher the setting, the stronger and more distinct the pan sound.

PARAMETERS ACCESSED BY THE INT PARAM KEY

Low-pass Filter Frequency (LPF FRQ.):

1.0 kHz–16 kHz, THRU

Permits rolling off the high-frequency content of the reverb signal above the set frequency. The LPF is OFF when set to THRU.

Gate Level (GATE LVL): 0–100%

This sets the threshold level of the program's internal noise gate. GATE LVL should be set so that noise is eliminated when no source signal is present, and the attack and decay portions of the source signal are passed as naturally as possible without abrupt transitions.

Programs 91 through 99 on the REV5 are a group of special combination programs which all include a five-parameter gate. Each combination program combines two separate effects and a gate. Although some combinations may appear to be the same effect (e.g. 93. SYMPHO. & REV & G, and 95. REV & SYMPHO. & G) the order in which the effects appear makes a significant difference in the final sound. In the case given above, for example, the results of applying reverb to a symphonic effect or, the reverse, applying symphonic to a reverb sound, are quite different.

Since the parameters contained in each combination effect are duplicates of those found in the individual effects, refer to the individual effects for complete descriptions of each parameter (exceptions will be noted). Refer to the "ROM CONTENTS AND CONTROLLABLE PARAMETERS" chart on page 56 for a complete listing of all the parameters available in each program.

THE GATE PARAMETERS

All combination programs (91–99) have the same five gate parameters (accessed via the INT PARAM key).

Trigger Level (TRG LEVEL): 0–100%

Determines the level of the input signal required to trigger "opening" of the gate. At 100% only very high-level input signals will trigger the gate, while at 0% even the tiniest input signal will trigger the gate.

Trigger Delay (TRG DLY): 0.1–1000.0 ms

Produces a delay between the time at which the gate is triggered and that at which it actually opens.

Hold Time (HOLD): 1–24000 ms

Determines how long the gate stays open, allowing the signal to pass.

Release Time (RELEASE): 3–24000 ms

Determines how long it takes for the gate to close fully after the HOLD has ended.

MIDI Trigger (MIDI TRG): OFF, ON

When this parameter is turned ON, a KEY ON EVENT message from an external MIDI keyboard can be used to trigger the gate. A KEY ON EVENT message is transmitted whenever a note on a MIDI keyboard is played.

91. ECHO & REV & G

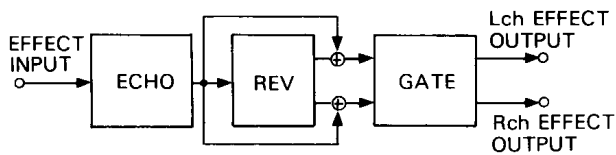

PARAMETERS ACCESSED BY THE PARAMETER KEY

Delay (DELAY): 0.1 – 1400.0 ms

This parameter corresponds to the Lch DLY and Rch DLY parameters of the DELAY & ECHO type programs.

Feedback Gain (F.B. GAIN): –99 – +99%

This parameter corresponds to the Lch FB and Rch FB parameters of the DELAY & ECHO type programs.

High Frequency Feedback (F.B. HIGH): $\times 0.1 – \times 1.0$

Reverb Time (REV TIME): 0.3 – 99.0 s

High Frequency Reverb Time Ratio (HIGH): $\times 0.1 – \times 1.0$

Low Frequency Reverb Time Ratio (LOW): $\times 0.1 – \times 2.4$

Diffusion (DIFFUSION): 0 – 10

REV MIX (Reverb Mix): 0 – 100%

Adjusts the amount of reverb mixed into the effect signal. Increasing the REV MIX value adds more reverb to the effect sound.

PARAMETERS ACCESSED BY THE INT PARAM KEY

Reverb Density (DENSITY): 1 – 4

Low-pass Filter Frequency (LPF FRQ.): 1.0 kHz – 16 kHz, THRU

Space Modulation (SPACE MOD): 0 – 10

Trigger Level (TRG LEVEL): 0 – 100

Trigger Delay (TRG DLY): 0.1 – 1000.0 ms

Hold Time (HOLD): 1 – 24000 ms

Release Time (RELEASE): 3 – 24000 ms

MIDI Trigger (MIDI TRG.): OFF, ON

92. CHORUS & REV & G

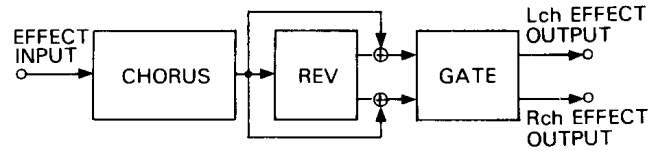

PARAMETERS ACCESSED BY THE PARAMETER KEY

Modulation Frequency (MOD. FRQ): 0.1 – 40.0 Hz

Delay Modulation Depth (DM DEPTH): 0 – 100%

Amplitude Modulation Depth (AM DEPTH): 0 – 100%

Reverb Time (REV TIME): 0.3 – 99.0 s

High Frequency Reverb Time Ratio (HIGH): $\times 0.1 – \times 1.0$

Low Frequency Reverb Time Ratio (LOW): $\times 0.1 – \times 2.4$

Diffusion (DIFFUSION): 0 – 10

REV MIX (Reverb Mix): 0 – 100%

Adjusts the amount of reverb mixed into the effect signal. Increasing the REV MIX value adds more reverb to the effect sound.

PARAMETERS ACCESSED BY THE INT PARAM KEY

Density (DENSITY): 1 – 4

Low-pass Filter Frequency (LPF FRQ.): 1.0 kHz – 16 kHz, THRU

Space Modulation (SPACE MOD): 0 – 10

Trigger Level (TRG LEVEL): 0 – 100

Trigger Delay (TRG DLY): 0.1 – 1000.0 ms

Hold Time (HOLD): 1 – 24000 ms

Release Time (RELEASE): 3 – 24000 ms

MIDI Trigger (MIDI TRG.): OFF, ON

93. SYMPHO. & REV & G

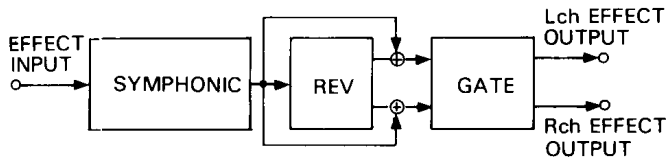

PARAMETERS ACCESSED BY THE PARAMETER KEY

Modulation Frequency (MOD. FRQ): 0.1 Hz—40.0 Hz

Modulation Depth (MOD. DEPTH): 0—100%

Reverb Time (REV TIME): 0.3—99.0 s

High Frequency Reverb Time Ratio (HIGH):
× 0.1— × 1.0

Low Frequency Reverb Time Ratio (LOW):
× 0.1— × 2.4

Diffusion (DIFFUSION): 0—10

REV MIX (Reverb Mix): 0—100%

Adjusts the amount of reverb mixed into the effect signal. Increasing the REV MIX value adds more reverb to the effect sound.

PARAMETERS ACCESSED BY THE INT PARAM KEY

Reverb Density (DENSITY): 1—4

Low-pass Filter Frequency (LPF FRQ.):
1.0 kHz—16 kHz, THRU

Space Modulation (SPACE MOD): 0—10

Trigger Level (TRG LEVEL): 0—100

Trigger Delay (TRG DLY): 0.1—1000.0 ms

Hold Time (HOLD): 1—24000 ms

Release Time (RELEASE): 3—24000 ms

MIDI Trigger (MIDI TRG.): OFF, ON

94. PC & REV & G

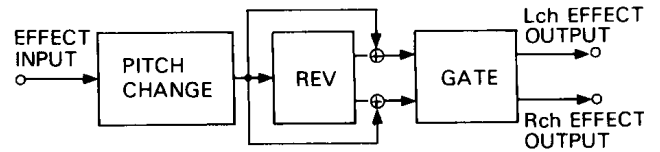

PARAMETERS ACCESSED BY THE PARAMETER KEY

Pitch Shift (PITCH): -12—+12

Fine Tuning (FINE): -100—+100

Delay Time (DELAY): 0.1—400.0 ms

Feedback Gain (F.B. GAIN): 0—99%

Base Key (BASE KEY): OFF, C1—C6

Reverb Time (REV TIME): 0.3—99.0 s

High Frequency Reverb Time Ratio (HIGH):
× 0.1— × 1.0

Low Frequency Reverb Time Ratio (LOW):
× 0.1— × 2.4

Diffusion (DIFFUSION): 0—10

REV MIX (Reverb Mix): 0—100%

Adjusts the amount of reverb mixed into the effect signal. Increasing the REV MIX value adds more reverb to the effect sound.

PARAMETERS ACCESSED BY THE INT PARAM KEY

Pitch/Reverb Balance (PITCH BAL): 0—100%

Density (DENSITY): 1—3

Low-pass Filter Frequency (LPF FRQ.):
1.0 kHz—16 kHz, THRU

Trigger Level (TRG LEVEL): 0—100

Trigger Delay (TRG DLY): 0.1—1000.0 ms

Hold Time (HOLD): 1—24000 ms

Release Time (RELEASE): 3—24000 ms

MIDI Trigger (MIDI TRG.): OFF, ON

95. REV & SYMPHONIC & G

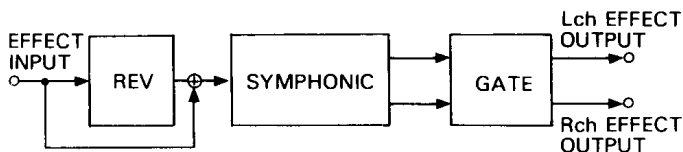

PARAMETERS ACCESSED BY THE PARAMETER KEY

Reverb Time (REV TIME): 0.3–99.0 s

High Frequency Reverb Time Ratio (HIGH):
× 0.1 – × 1.0

Low Frequency Reverb Time Ratio (LOW):
× 0.1 – × 2.4

Diffusion (DIFFUSION): 0–10

Modulation Frequency (MOD. FRQ): 0.1 Hz–40.0 Hz

Modulation Depth (MOD. DEPTH): 0–100%

REV MIX (Reverb Mix): 0–100%

Adjusts the amount of reverb mixed into the effect signal. Increasing the REV MIX value adds more reverb to the effect sound.

PARAMETERS ACCESSED BY THE INT PARAM KEY

Reverb Density (DENSITY): 1–4

Low-pass Filter Frequency (LPF FRQ.):
1.0 kHz–16 kHz, THRU

Space Modulation (SPACE MOD): 0–10

Trigger Level (TRG LEVEL): 0–100

Trigger Delay (TRG DLY): 0.1–1000.0 ms

Hold Time (HOLD): 1–24000 ms

Release Time (RELEASE): 3–24000 ms

MIDI Trigger (MIDI TRG.): OFF, ON

96. REV & PAN & G

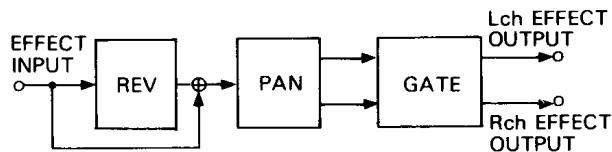

PARAMETERS ACCESSED BY THE PARAMETER KEY

Reverb Time (REV TIME): 0.3–99.0 s

High Frequency Reverb Time Ratio (HIGH):
× 0.1 – × 1.0

Low Frequency Reverb Time Ratio (LOW):
× 0.1 – × 2.4

Diffusion (DIFFUSION): 0–10

Pan Speed (PAN SPEED): 0.1–40.0 Hz

Pan Direction (DIRECTION): L→R, L←R, L↔R

Pan Depth (DEPTH): 0–100%

REV MIX (Reverb Mix): 0–100%

Adjusts the amount of reverb mixed into the effect signal. Increasing the REV MIX value adds more reverb to the effect sound.

PARAMETERS ACCESSED BY THE INT PARAM KEY

Reverb Density (DENSITY): 1–4

Low-pass Filter Frequency (LPF FRQ.):
1.0 kHz–16 kHz, THRU

Space Modulation (SPACE MOD): 0–10

Trigger Level (TRG LEVEL): 0–100

Trigger Delay (TRG DLY): 0.1–1000.0 ms

Hold Time (HOLD): 1–24000 ms

Release Time (RELEASE): 3–24000 ms

MIDI Trigger (MIDI TRG.): OFF, ON

97. REV & PC & G

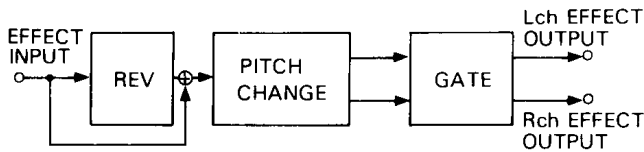

PARAMETERS ACCESSED BY THE PARAMETER KEY

Reverb Time (REV TIME): 0.3–99.0 s

High Frequency Reverb Time Ratio (HIGH):
× 0.1 – × 1.0

Low Frequency Reverb Time Ratio (LOW):
× 0.1 – × 2.4

Diffusion (DIFFUSION): 0–10

Left Pitch Shift (L PITCH): –12–+12

Left Fine Tuning (L FINE): –100–+100

Left Delay Time (L DLY): 0.1–200.0 ms

Right Pitch Shift (R PITCH): –12–+12

Right Fine Tuning (R FINE): –100–+100

Right Delay Time (R DLY): 0.1–200.0 ms

Base Key (BASE KEY): OFF, C1–C6

REV MIX (Reverb Mix): 0–100%

Adjusts the amount of reverb mixed into the effect signal. Increasing the REV MIX value adds more reverb to the effect sound.

PARAMETERS ACCESSED BY THE INT PARAM KEY

Pitch/Reverb Balance (PITCH BAL): 0–100%

Density (DENSITY): 1–3

Low-pass Filter Frequency (LPF FRQ.):
1.0 kHz–16 kHz, THRU

Trigger Level (TRG LEVEL): 0–100

Trigger Delay (TRG DLY): 0.1–1000.0 ms

Hold Time (HOLD): 1–24000 ms

Release Time (RELEASE): 3–24000 ms

MIDI Trigger (MIDI TRG.): OFF, ON

98. ER + REV & G

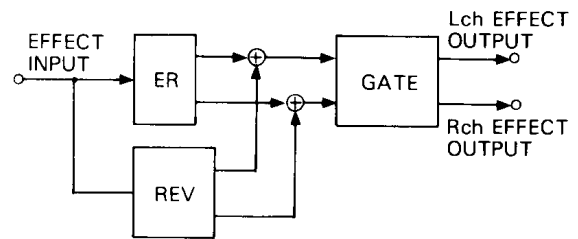

PARAMETERS ACCESSED BY THE PARAMETER KEY

Early Reflection Mode (MODE): S-HALL, L-HALL, RANDOM, REVERSE, PLATE, SPRING, PAN-A, PAN-B

Liveness (LIVENESS): 0–10

Room Size (ROOM SIZE): 0.1–25.0

Early Reflection Diffusion (ER DIF): 0–10

This parameter corresponds to the DIFFUSION parameter of the EARLY REFLECTION type programs.

Reverb Time (REV TIME): 0.3–99.0 s

High Frequency Reverb Time Ratio (HIGH):
× 0.1 – × 1.0

Low Frequency Reverb Time Ratio (LOW):
× 0.1 – × 2.4

Reverb Diffusion (REV DIF): 0–10

This parameter corresponds to the DIFFUSION parameter of the REVERB type programs.

99. PLATE + HALL & G

PARAMETERS ACCESSED BY THE INT PARAM KEY

Early Reflection/Reverb Balance (ER/REV BAL):
0 – 100%

Early Reflection Delay (ER DLY): 0.1 – 500.0 ms

Sets the time delay between the input signal and the beginning of the early reflection sound.

Number of Early Reflections (ER NUMBER): 1 – 14

Reverb Delay (REV DLY): 0.1 – 500.0 ms

Sets the time delay between the input signal and the beginning of the reverb sound.

Reverb Density (DENSITY): 1 – 4

Low-pass Filter Frequency (LPF FRQ.):
1.0 kHz – 16 kHz, THRU

Space Modulation (SPACE MOD.): 0 – 10

Trigger Level (TRG LEVEL): 0 – 100

Trigger Delay (TRG DLY): 0.1 – 1000.0 ms

Hold Time (HOLD): 1 – 24000 ms

Release Time (RELEASE): 3 – 24000 ms

MIDI Trigger (MIDI TRG.): OFF, ON

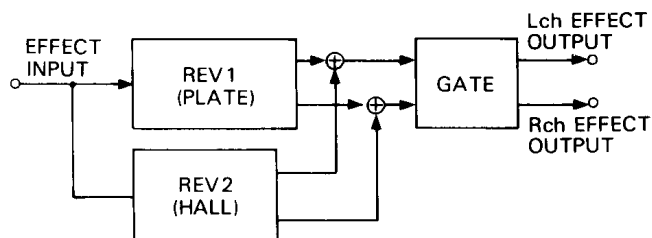

PARAMETERS ACCESSED BY THE PARAMETER KEY

1st Reverb Time (REV1 TIME): 0.3 – 99.0 s

1st High Frequency Reverb Time Ratio (1 HIGH):
× 0.1 – × 1.0

1st Low Frequency Reverb Time Ratio (1 LOW):
× 0.1 – × 2.4

1st Reverb Diffusion (1 DIFFUSION): 0 – 10

2nd Reverb Time (REV2 TIME): 0.3 – 99.0 s

2nd High Frequency Reverb Time Ratio (2 HIGH):
× 0.1 – × 1.0

2nd Low Frequency Reverb Time Ratio (2 LOW):
× 0.1 – × 2.4

2nd Reverb Diffusion (2 DIFFUSION): 0 – 10

PARAMETERS ACCESSED BY THE INT PARAM KEY

1st Reverb/2nd Reverb Balance (REV1/2 BAL):
0 – 100%

1st Reverb Delay (REV1 DLY): 0.1 – 500.0 ms

2nd Reverb Delay (REV2 DLY): 0.1 – 500.0 ms

Density (DENSITY): 1 – 4

Low-pass Filter Frequency (LPF FRQ.):
1.0 kHz – 16 kHz, THRU

Space Modulation (SPACE MOD.): 0 – 10

Trigger Level (TRG LEVEL): 0 – 100

Trigger Delay (TRG DLY): 0.1 – 1000.0 ms

Hold Time (HOLD): 1 – 24000 ms

Release Time (RELEASE): 3 – 24000 ms

MIDI Trigger (MIDI TRG.): OFF, ON

4: UTILITY FUNCTIONS

The REV5 UTILITY key provides access to a number of important functions. Each press on the UTILITY key advances to the next function until the UTILITY mode is exited:

TITLE EDIT → MIDI CONTROL → BULK OUT →
F.SW MEMORY RCL RANGE → exit UTILITY mode.

TITLE EDIT

This function makes it possible to create original titles for programs you edit and store in memory locations 31 through 90. The TITLE EDIT function is the first one to appear when the UTILITY key is pressed. The "TITLE EDIT" function name appears on the bottom line of the LCD, and an underline cursor appears at the first character position on the top line. The PARAMETER and LEVEL keys are used to move the cursor back and forth (their LEDs light when this function is called), while the Δ and ▽ keys are used to select a new character for the current cursor position. Simply move the cursor to each character position in turn, selecting the appropriate characters at each position.

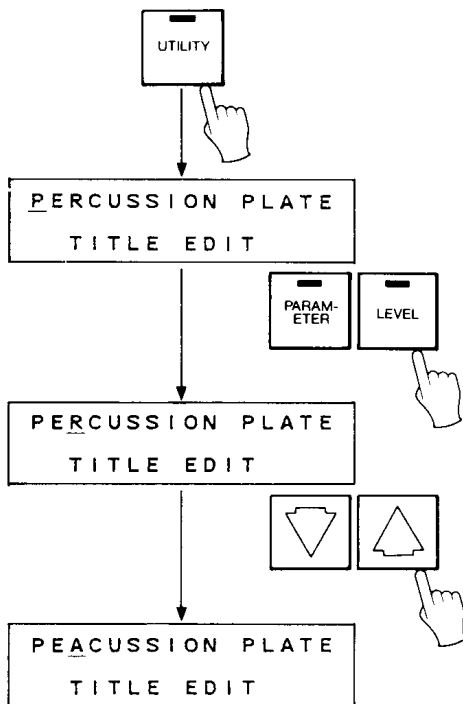

* Since the contents of the preset programs can not be changed, attempting to edit the title of one of these programs produces the following display.

RAM (31-90) ONLY
TITLE EDIT

The available characters are as follows:

「	」	”	’	—	ア	ァ	イ	ィ	ウ	ゥ	エ	ェ	オ	ォ	カ	キ	ク
ケ	コ	サ	シ	ス	セ	ソ	タ	チ	ツ	ッ	テ	ト	ナ	ニ	ヌ	ネ	ノ
ハ	ヒ	フ	ヘ	ホ	マ	ミ	ム	メ	モ	ヤ	ユ	ヨ	ラ	リ			
ル	レ	ロ	ワ	ラン		#	0	1	2	3	4	5	6	7	8	9	
	A	B	C	D	E	F	G	H	I	J	K	L	M	N	O	P	Q
R	S	T	U	V	W	X	Y	Z		a	ä	b	c	d	e	f	g
h	i	j	k	l	m	n	o	ö	p	q	r	s	t	u	ü	v	w
x	y	z															
	%	!	?	*	.												

* A [space] can also be entered by pressing the CLEAR key.

MIDI BANK & CHANNEL ASSIGNMENT

The REV5 makes it possible to select specific programs via external MIDI control. You can set up the REV5, for example, so that when you select a voice on your synthesizer the most appropriate effect for that voice is automatically selected. This is accomplished because each time you select a voice on your MIDI synthesizer it transmits the corresponding MIDI PROGRAM CHANGE NUMBER. The REV5 receives this PROGRAM CHANGE NUMBER and selects the effect program that you have assigned to it using the MIDI PROG CHANGE function which will be described below. The REV5 also accepts MIDI KEY ON EVENT messages to trigger some of the gate effects, and MIDI KEY ON NUMBERS to set the PITCH parameter of the PITCH CHANGE effects.

The REV5 actually can be programmed with four completely independent sets of MIDI PROGRAM CHANGE NUMBER/MEMORY NUMBER assignments. Each of these is contained in a different "bank": A, B, C or D. Each BANK may also be programmed to receive on a different MIDI channel. An example of the way the four banks may be programmed with different receive channels and program number/memory number assignments is given below:

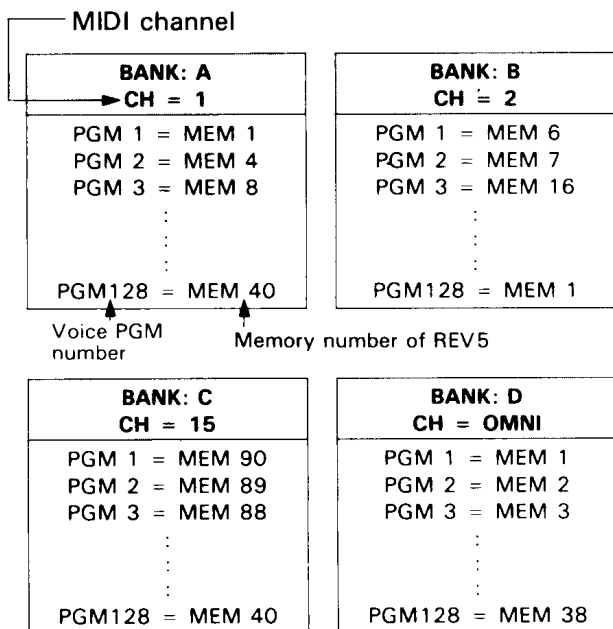

1 Bank Selection and MIDI Channel Programming

- ① Press the UTILITY key until the MIDI CONTROL function appears (MIDI CONTROL is the second function on the UTILITY "list").
- ② Use the Δ and ∇ keys to select the bank to program.
- ③ Press the LEVEL key or the PARAMETER Key to move the cursor.
- ④ Use the Δ and ∇ keys to set the MIDI channel (1–16), the OMNI mode (all channels can be received), or turn MIDI reception OFF for the selected bank.

*Press the PARAMETER key or the LEVEL key to move the cursor to another side.

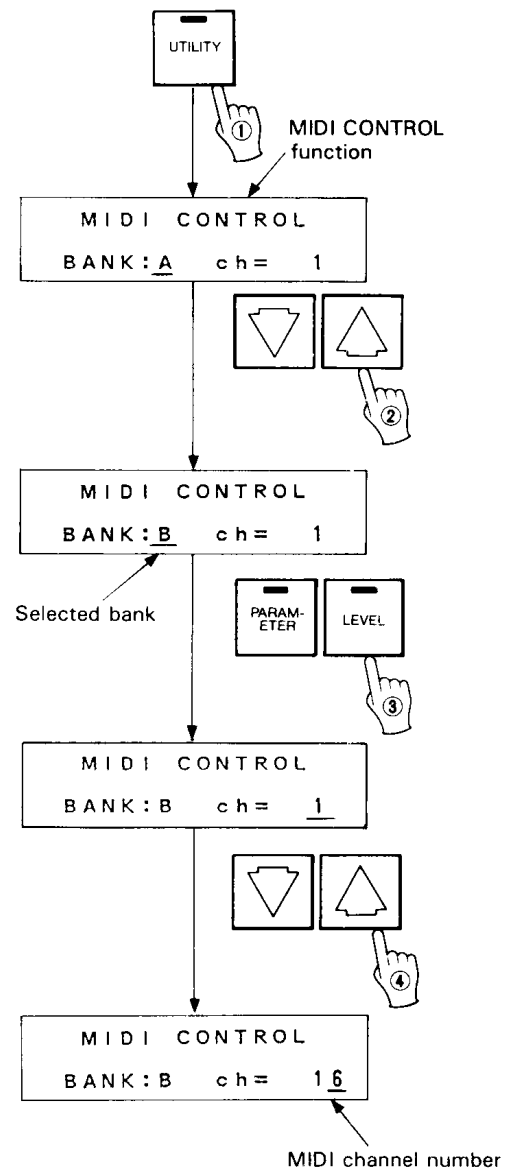

2 Assigning Effects to MIDI Program Change Numbers

- ① Select the MIDI CONTROL mode using the UTILITY key to select the program change number assignment mode. Press the utility key once more to select the program change assignment mode.
- ② Use the Δ and ∇ keys to select the program change number to which a new REV5 memory location number is to be assigned. The range of available program change numbers is from 1 to 128.
- ③ Use the Numeric/Editing Keys to enter memory location number containing the effect which is to be assigned to the currently selected program change number.
- ④ Press the STORE key to store the assigned numbers.

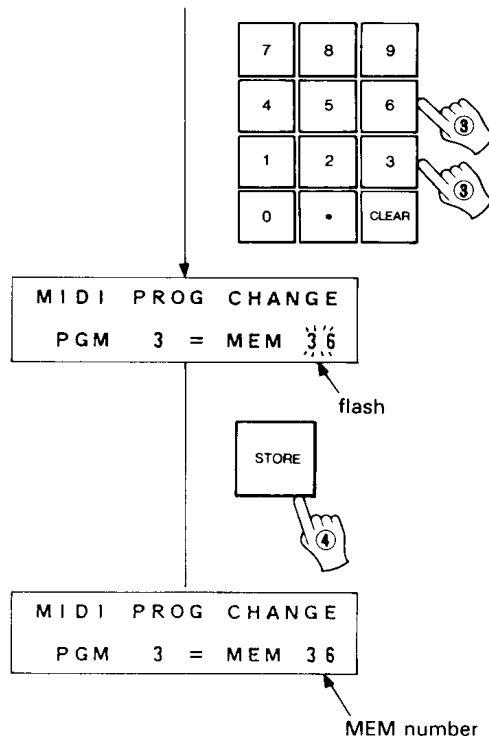
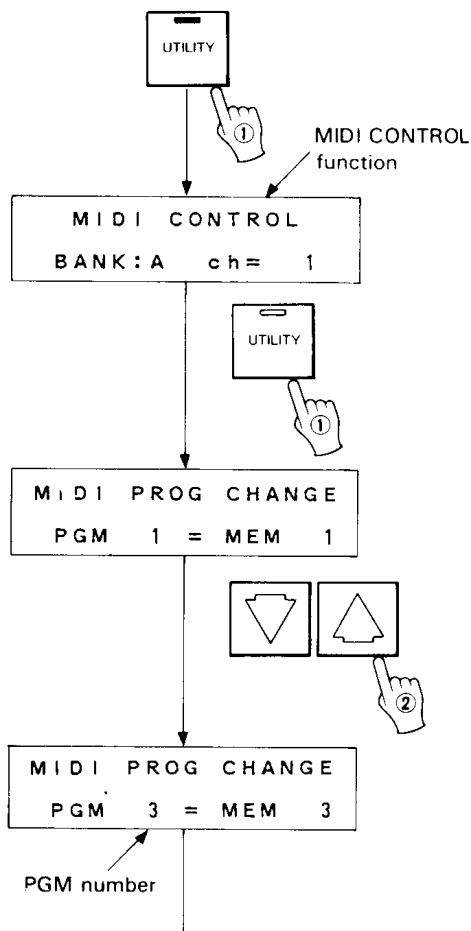

- ⑤ Repeat steps ②, ③ and ④ to assign as many program change numbers as necessary.

NOTE: The program number/memory number assignments made are stored in the BANK selected in the previous MIDI CONTROL function. To program the program change/memory number assignments for a different BANK, return to the MIDI CONTROL mode, select the desired BANK, then program the required assignments.

BULK OUT

This function permits dumping program data and/or BANK MIDI assignments via the MIDI OUT terminal (The MIDI THRU/OUT terminal must be switched to MIDI).

- ① Press the UTILITY key several times until the BULK OUT function appears (the BULK OUT function is the fourth function on the UTILITY "list").
- ② Press the LEVEL key or the PARAMETER key to select either the ALL, MEM or BANK functions.
- ③ If you selected ALL, simply press the RECALL/ENTER key to execute a bulk dump of memory locations 31 through 90 as well as all BANK MIDI assignments (MIDI channels and program change number assignments for all four BANKs).
- ④ If you select MEM, simply press RECALL/ENTER to execute a bulk dump of the currently selected memory location (1–99) by pressing the Δ and ∇ keys.
- ⑤ If you select BANK, press the RECALL/ENTER key to execute a bulk dump of all MIDI assignments for the currently selected BANK by pressing the Δ and ∇ keys (MIDI channel and program change number assignments).

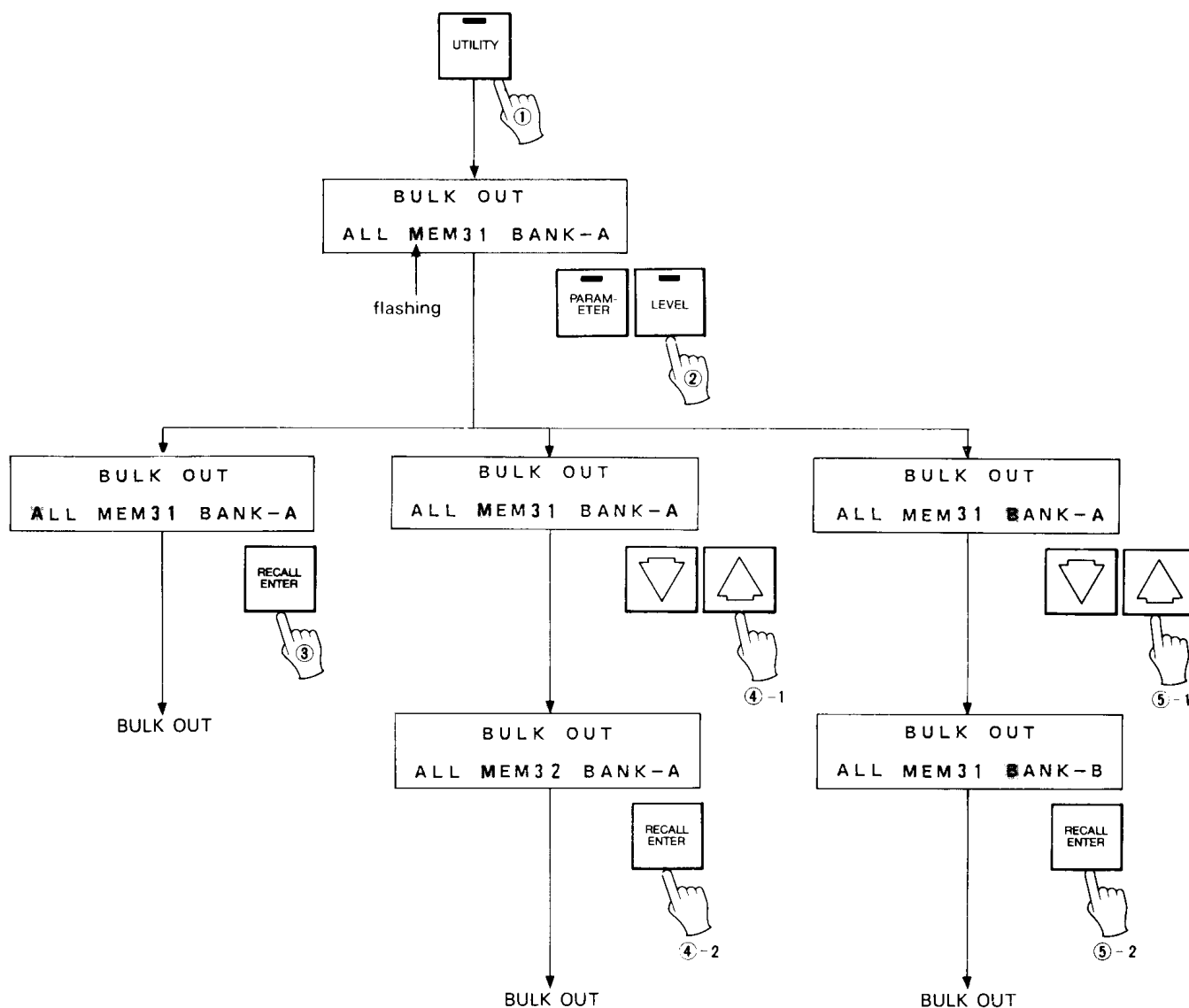

FOOTSWITCH MEMORY RECALL RANGE

The REV5 permits memory selection via an optional Yamaha FC5 footswitch connected to the "MEMORY" footswitch jack. The fourth function accessed by the UTILITY key—F.SW MEMORY RCL—permits setting the range of memory location numbers that will be selected when the footswitch is pressed.

F. SW MEMORY RCL
RANGE 1 TO 99

If, for example, the RANGE parameter is set to "1 TO 99" as shown in the LCD illustration above, each time the footswitch is pressed the next highest memory location will be selected until the last number in the specified range is reached. After the last number in the specified range, the first (lowest) number is selected and the process repeated. Reverse sequences can be programmed by entering the highest number in the range before the lowest, as shown below.

F. SW MEMORY RCL
RANGE 34 TO 31

In this case the selection sequence is: 34 → 33 → 32 → 31 → 34, etc.

- ① Press the UTILITY key the required number of times to call the F.SW MEMORY RCL function.
- ② Use the Δ and ∇ keys (or numeric entry keys followed by the STORE key) to enter the first number in the range.
- ③ Press the LEVEL or the PARAMETER key to move the cursor to the second number in the range.
- ④ Use the Δ or ∇ keys (or numeric entry keys followed by the STORE key) to enter the second number in the range.

*Press the LEVEL or the PARAMETER key to move the cursor to the first number in the range.

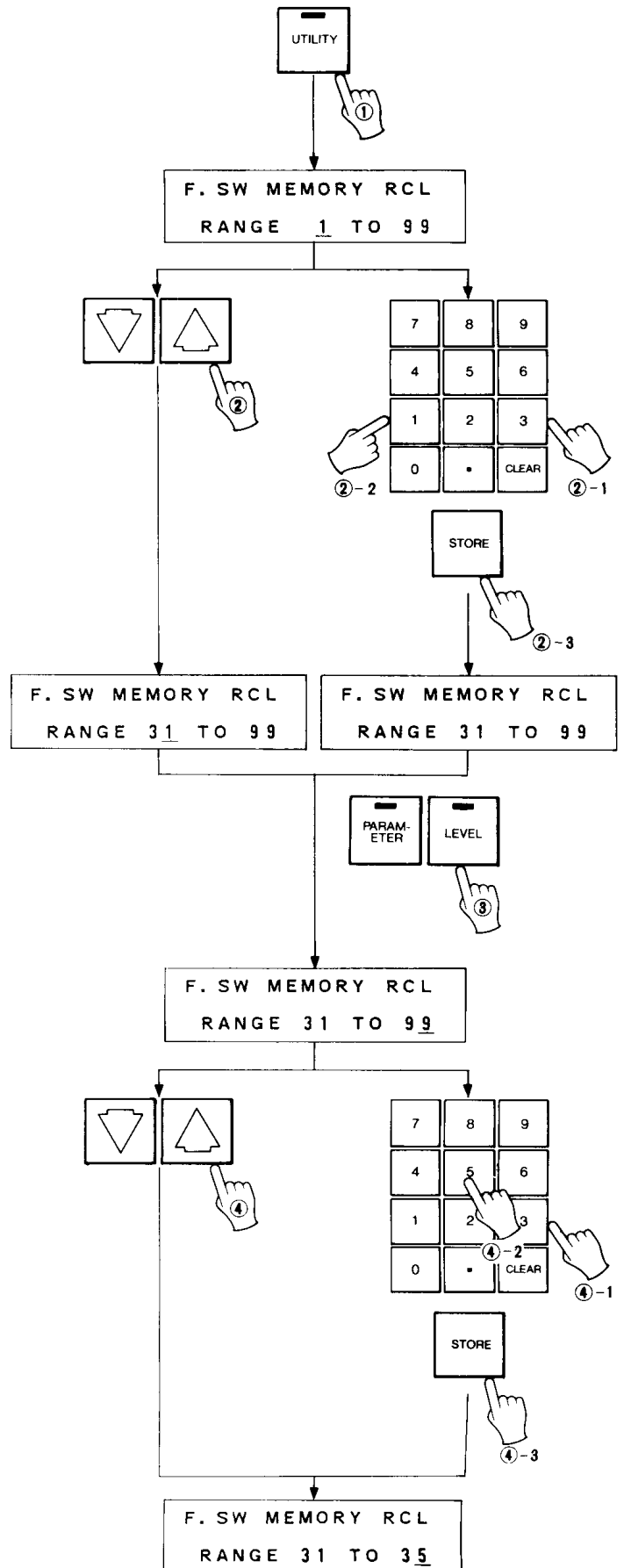

5: MIDI DATA FORMAT

1. Transmission Conditions

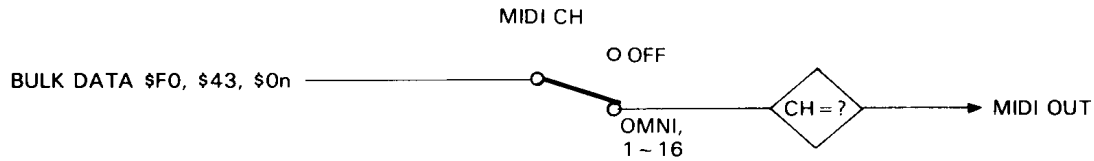

2. Transmission Data

2-1 System Information

1) System Exclusive Message

① 1 MEMORY BULK DATA

Can be transmitted on the MIDI channel set in the currently active bank.

The data is transmitted when the appropriate REV5 BULK OUT function is executed or when a bulk dump request is received from external equipment. The transmitted data consists of the contents of the specified memory number.

STATUS	11110000 (F0H)	
ID No.	01000011 (43H)	
SUB-STATUS	0000nnnn (0nH)	n = 0 (channel no.1) ~ 15 (channel no.16)
FORMAT No.	01111110 (7EH)	
BYTE COUNT	00000001 (01H)	
BYTE COUNT	01110010 (72H)	
	01001100 (4CH)	"L"
	01001101 (4DH)	"M"
	00100000 (20H)	space
	00100000 (20H)	spece
	00111000 (38H)	"8"
	00110011 (33H)	"3"
	00110100 (34H)	"4"
	00110101 (35H)	"5"
DATA NAME	01001101 (4DH)	"M"
MEMORY No.	0mmmmmm	m = 1 (memory no.1) ~ 99 (memory no.99)
DATA	0ddddddd] 232 bytes
	0ddddddd	
CHECKSUM	0eeeeeee	
EOX	11110111 (F7H)	

② 1 BANK PROGRAM CHANGE ASSIGNMENT TABLE BULK DATA

Can be transmitted on the MIDI channel set in the currently active bank.

The data is transmitted when the appropriate REV5 BULK OUT function is executed or when a program change assignment table bulk dump request is received. The data transmitted consists of the program change assignment table (assignment of MIDI program change numbers to memory numbers).

STATUS	11110000 (F0H)	
ID No.	01000011 (43H)	
SUB-STATUS	0000nnnn (0nH)	n = 0 (channel no.1) ~ 15 (channel no.16)
FORMAT No.	01111110 (7EH)	
BYTE COUNT	00000001 (01H)	
BYTE COUNT	00001010 (0AH)	
	01001100 (4CH)	"L"
	01001101 (4DH)	"M"
	00100000 (20H)	space
	00100000 (20H)	space
	00111000 (38H)	"8"
	00110011 (33H)	"3"
	00110100 (34H)	"4"
	00110101 (35H)	"5"
DATA NAME	01010100 (54H)	"T"
BANK No.	0zzzzzzz	z = bank 1~4 (1=A, 2=B, 3=C, 4=D)
DATA	0ddddddd] 128 bytes
	0ddddddd	
CHECKSUM	0eeeeeee	
EOX	11110111 (F7H)	

③ **60 MEMORY & 4 BANK PROGRAM CHANGE ASSIGNMENT TABLE BULK DATA**

Can be transmitted on the MIDI channel set in the currently active bank.

The data is transmitted when the BULK DUMP ALL function is activated. The data in memory locations 31 through 90 is transmitted then the program change assignment tables for all four banks are transmitted.

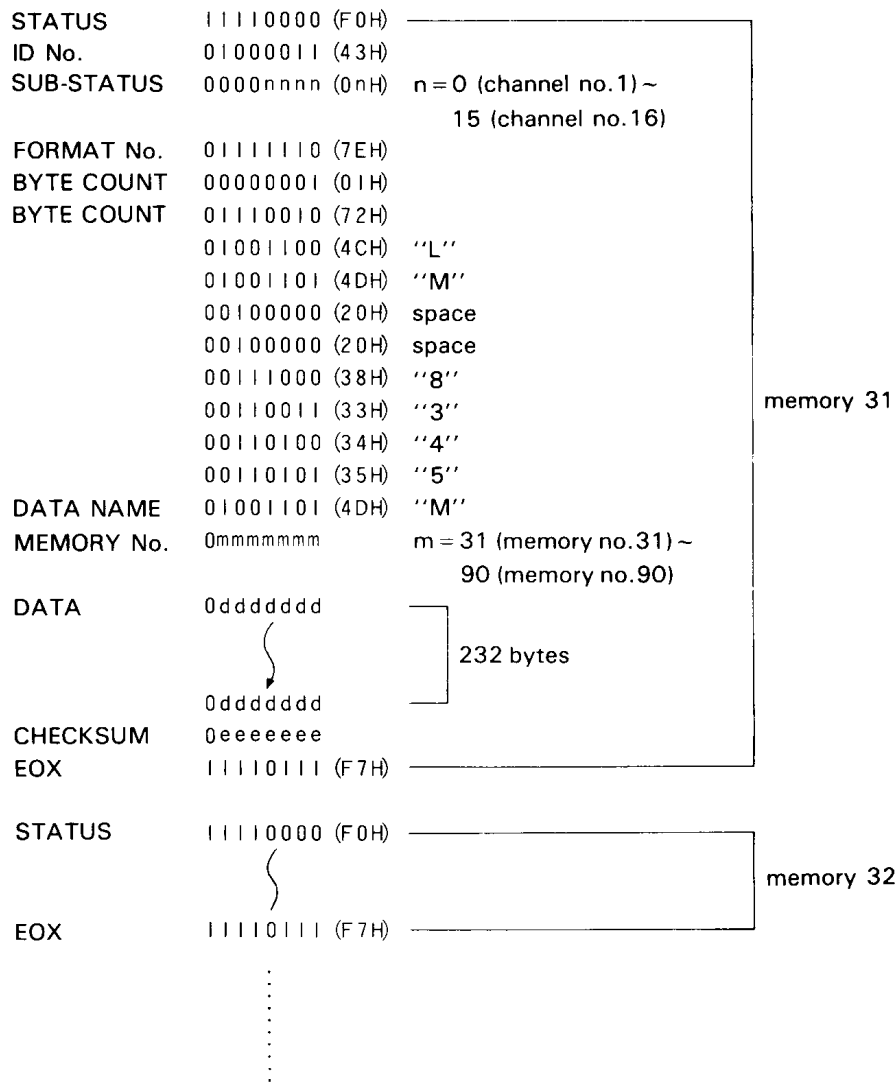

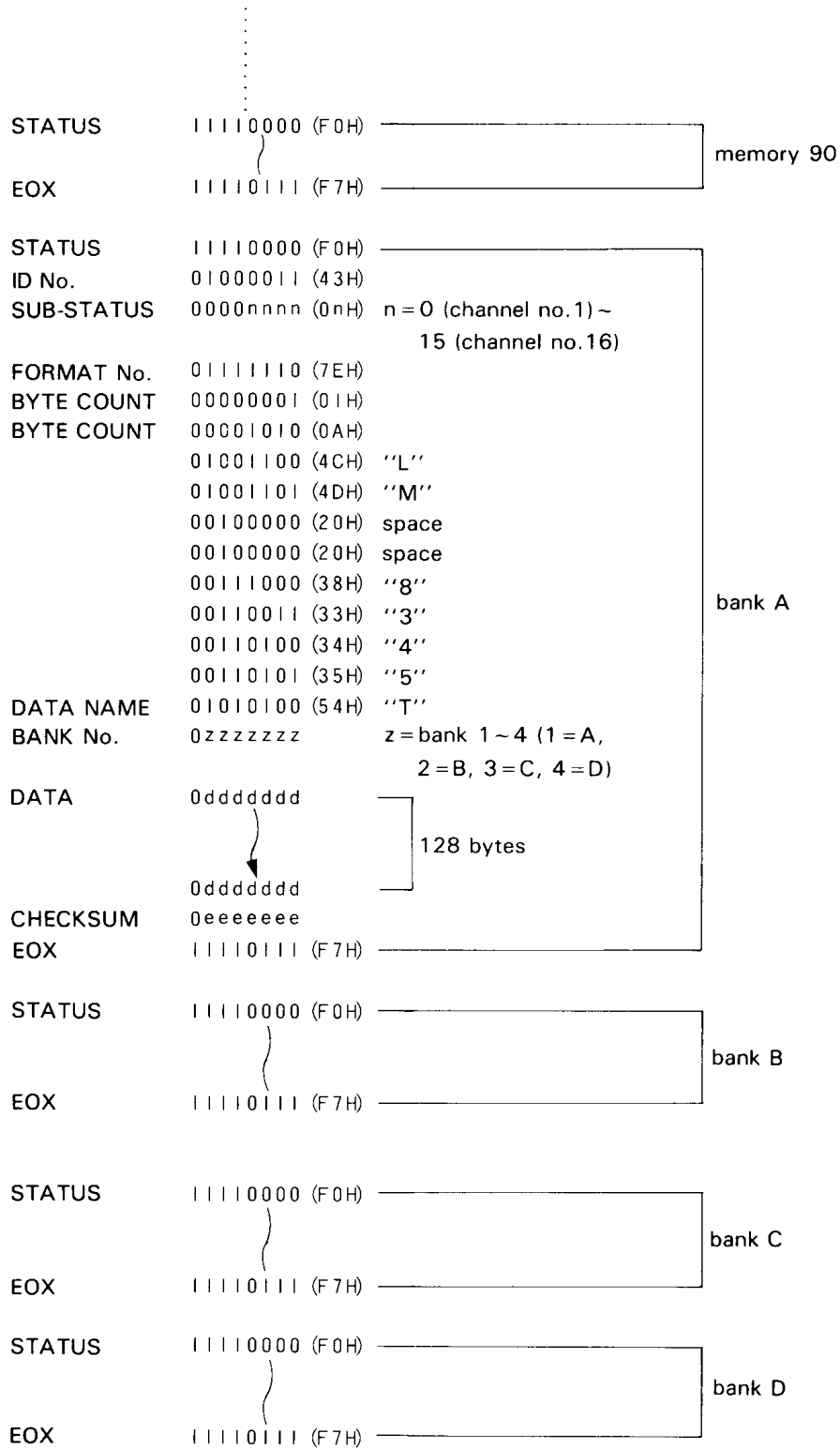

3. Reception Conditions

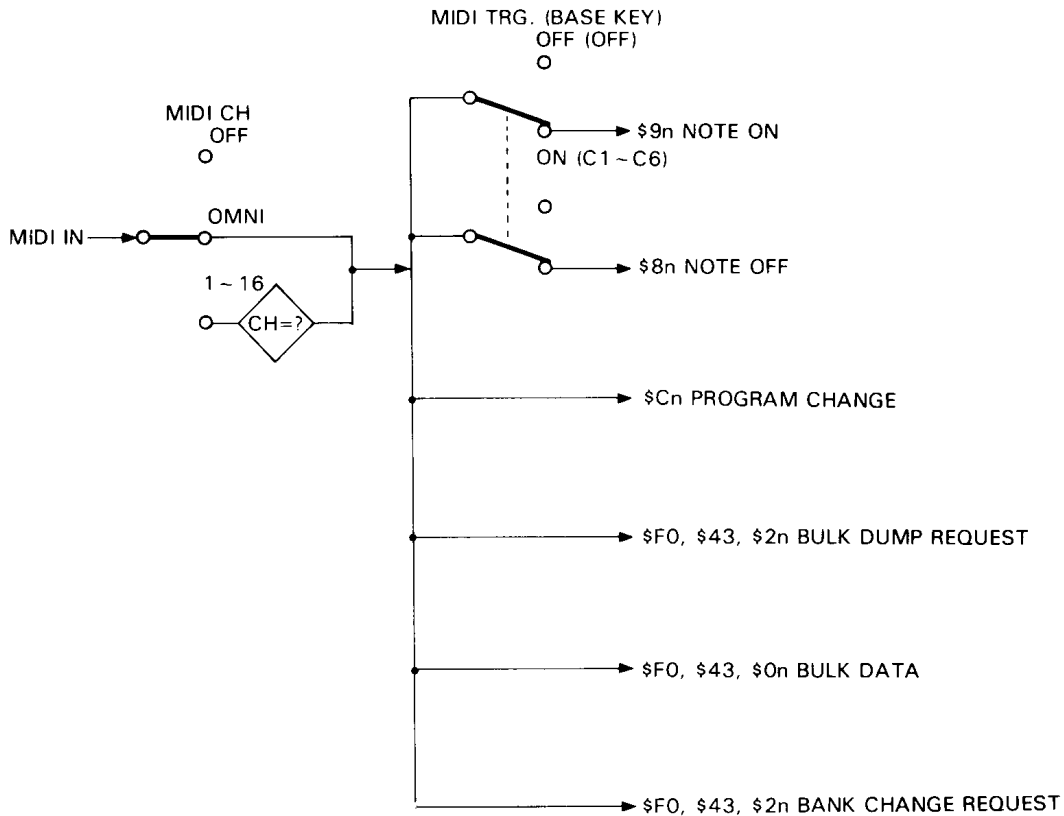

4. Reception Data

4-1 Channel Information

1) Channel Voice Message

① NOTE ON

Can be received on the MIDI channel set in the currently active bank.
 When Programs 23 or 91—99 are selected and their MIDI TRG. parameter is turned ON, the received NOTE ON message functions as a MIDI trigger signal. When programs 26—28 are selected, the received NOTE ON message functions to set the BASE KEY for the selected effect as long as the BASE KEY parameter is not set to OFF.

STATUS	1001nnnn (9nH)	n = 0 (channel no.1) ~ 15 (channel no.16)
NOTE No.	0kkkkkkk	k = 0 (C 2) ~ 127 (G8)
VELOCITY	0vvvvvvv	v = 0 ~ 127

② NOTE OFF

Although this message causes no direct action in the REV5, it is essential to signal the end of a NOTE ON message. The conditions for NOTE OFF message reception are the same as for NOTE ON reception, as described above.

STATUS	1000nnnn (8nH)	n = 0 (channel no.1) ~ 15 (channel no.16)
NOTE No.	0kkkkkkk	k = 0 (C 2) ~ 127 (G8)
VELOCITY	0vvvvvvv	V = 0 ~ 127

③ PROGRAM CHANGE

Can be received on the MIDI channel set in the currently active bank.
 The effect assigned to the received program number in the program assignment table will be selected.

STATUS	1100nnnn (CnH)	n = 0 (channel no.1) ~ 15 (channel no.16)
PROGRAM No.	0ppppppp	p = 0 ~ 127

4-2 System Information

1) System Exclusive Message

① MEMORY BULK DUMP REQUEST

Can be received on the MIDI channel set in the currently active bank.

When received, a bulk dump of the specified memory is performed.

STATUS	11110000 (F0H)	
ID No.	01000011 (43H)	
SUB-STATUS	0010nnnn (2nH)	n=0 (channel no.1)~ 15 (channel no.16)
FORMAT No.	01111110 (7EH)	
	01001100 (4CH)	"L"
	01001101 (4DH)	"M"
	00100000 (20H)	space
	00100000 (20H)	space
	00111000 (38H)	"8"
	00110011 (33H)	"3"
	00110100 (34H)	"4"
	00110101 (35H)	"5"
DATA NAME	01001101 (4DH)	"M"
MEMORY No.	0yyyyyyy	y=1 (memory no.1)~ 99 (memory no.99)
EOX	11110111 (F7H)	

② PROGRAM CHANGE ASSIGNMENT TABLE BULK DUMP REQUEST

Can be received on the MIDI channel set in the currently active bank.

When received the program change assignment table of the specified bank is bulk-dumped. The bulk dump data consists of the specified program change assignment table (assignment of MIDI program change numbers to memory numbers).

STATUS	11110000 (F0H)	
ID No.	01000011 (43H)	
SUB-STATUS	0010nnnn (2nH)	n=0 (channel no.1)~ 15 (channel no.16)
FORMAT No.	01111110 (7EH)	
	01001100 (4CH)	"L"
	01001101 (4DH)	"M"
	00100000 (20H)	space
	00100000 (20H)	space
	00111000 (38H)	"8"
	00110011 (33H)	"3"
	00110100 (34H)	"4"
	00110101 (35H)	"5"
DATA NAME	01010100 (54H)	"T"
BANK No.	0zzzzzzz	z=bank 1~4 (1=A, 2=B, 3=C, 4=D)
EOX	11110111 (F7H)	

③ BANK CHANGE REQUEST

Can be received on the MIDI channel set in the currently active bank.

When received the specified bank is selected.

STATUS	11110000 (F0H)	
ID No.	01000011 (43H)	
SUB-STATUS	0010nnnn (2nH)	n=0 (channel no.1)~ 15 (channel no.16)
FORMAT No.	01111110 (7EH)	
	01001100 (4CH)	"L"
	01001101 (4DH)	"M"
	00100000 (20H)	space
	00100000 (20H)	space
	00111000 (38H)	"8"
	00110011 (33H)	"3"
	00110100 (34H)	"4"
	00110101 (35H)	"5"
DATA NAME	01010101 (55H)	"U"
BANK No.	0zzzzzzz	z=bank 1~4 (1=A, 2=B, 3=C, 4=D)
EOX	11110111 (F7H)	

④ 1 MEMORY BULK DATA

Same as "1 MEMORY BULK DATA" in "Transmission DATA" section.

⑤ 1 BANK PROGRAM CHANGE ASSIGNMENT TABLE BULK DATA

Same as "1 BANK PROGRAM CHANGE ASSIGNMENT TABLE BULK DATA" in "Transmission Data" section.

⑥ 60 MEMORY & 4 BANK PROGRAM CHANGE ASSIGNMENT TABLE BULK DATA

Same as "60 MEMORY & 4 BANK PROGRAM CHANGE ASSIGNMENT TABLE BULK DATA" in "Transmission Data" section.

When bulk data is to be received from the Yamaha MDF1 MIDI Data Filer, a computer or similar storage device, it is necessary to set the data transmission interval (F7H—F0H) of the storage to greater than 30 milliseconds.

Function ...	Transmitted	Recognized	Remarks
Basic Default	x	1 - 16, off	memorized
Channel Changed	x	1 - 16, off	
Mode Default	x	OMNION/OMNIOFF	memorized
Mode Messages	x	x	
Mode Altered	XXXXXXXXXXXXXXXX	x	
Note Number : True voice	x XXXXXXXXXXXXXXXX	0 - 127 X1 x	
Velocity Note ON	x	x	
Velocity Note OFF	x	x	
After Touch Key's	x	x	
After Touch Ch's	x	x	
Pitch Bender	x	x	
Control Change	x	x	
Prog Change : True #	x XXXXXXXXXXXXXXXX	0 0 - 127 X2	
System Exclusive	o	o	Bulk dump
System : Song Pos	x	x	
System : Song Sel	x	x	
Common : Tune	x	x	
System : Clock	x	x	
Real Time : Commands	x	x	
Aux : Local ON/OFF	x	x	
Aux : All Notes OFF	x	x	
Mes- : Active Sense	x	x	
sages:Reset	x	x	
Notes	X1 Note ON/OFF is recognized only for pitch change and MIDI trigger. X2 For program 1 - 128, memory #1 - #99 is selected.		

Mode 1 : OMNI ON, POLY Mode 2 : OMNI ON, MONO o : Yes
 Mode 3 : OMNI OFF, POLY Mode 4 : OMNI OFF, MONO x : No